

Paper Mill Lane Works

Traffic Management Plan

DCO Requirement 16 (3) and 27 (1)(a)

(Applicable to Work Numbers 50 and 51)

Prepared by:	Checked by:	Approved by:
<i>K Griffin, SLR</i>		

Revision Summary				
Rev	Date	Prepared by	Checked by	Approved by
1	31/08/21	K Griffin	Phil Williamson Rew-	Catherine Sibley
2	28/01/22	Kay Griffin	Phil Williamson Rew	Gareth Mills
3	01/04/22	Kay Griffin	Phil Williamson Rew	Gareth Mills
4	24/05/22	Kay Griffin	Mark Foden	Catherine Sibley

Description of Revisions			
Rev	Page	Section	Description
1	All	All	New Document
2	All	All	Amended in accordance with comments received on the Interim Draft Document from SCC (12/10/21 and 15/10/21)
3	All	All	Amended in accordance with comments received on the Final Draft Document from SCC (25/02/22)
4	13	4	Amended in accordance with comments received from SCC Highways

FOR DISCUSSION

TABLE OF CONTENTS

1. INTRODUCTION AND SCOPE	5
1.1 Project Overview	5
1.2 Purpose and Scope.....	5
2. ABBREVIATIONS	6
3. CONSTRUCTION DETAILS	7
3.1 Cable Works – Overview	7
3.2 Paper Mill Lane Works	8
3.2.1 Accesses AP-AF and AP-AG, Access Track, Haul Road and Trackway (Work No. 50)	9
3.2.2 Primary Construction Consolidation Site (Work No. 51).....	9
3.2.3 Jointing Bay 4 (Work No. 51)	10
3.2.4 Reinstatement.....	10
3.3 Temporary Infrastructure Access Locations	11
3.4 Construction Traffic	11
3.4.1 HGV Movements.....	11
3.4.2 Abnormal Load Movements	12
4. TRAFFIC MANAGEMENT PLAN GOVERNANCE	13
5. LOCAL COMMUNITY LIAISON	13
6. TRAFFIC MANAGEMENT MEASURES	14
6.1 General Principles	14
6.2 HGV Route Assessment	14
6.3 Abnormal Load Route Assessment	14
6.4 Routeing.....	15
6.5 Crossing Points	17
6.6 Delivery Times.....	17
6.7 Training	18
6.8 Control of HGV Numbers	18
6.9 Signage.....	18
6.10 Pre and Post Construction Surveys.....	19
6.11 Additional controls	19
7. HIGHWAYS AND ACCESS IMPROVEMENTS	20
7.1 Highways Improvements	20
7.2 Access Improvements	20
7.3 Traffic Appraisal	20
8. MONITORING AND ENFORCEMENT	21
8.1 Monitoring.....	21
8.1.1 HGV Numbers.....	21
8.1.2 HGV Routing.....	21

8.2	Enforcement.....	21
8.2.1	Introduction.....	21
8.2.2	Potential Breaches.....	21
8.2.3	Corrective Process.....	21
8.2.4	Action Plan.....	22
9.	REFERENCES.....	23
	APPENDIX 1 EAST ANGLIA THREE CONVERTER STATION AND PAPER MILL LANE WORKS TRAFFIC AND TRANSPORT TECHNICAL NOTE.....	24
	APPENDIX 2 NKT UK EA3 HVDC ROUTE COMMENCEMENT WORKS TRANSPORT ASSESSMENT APRIL 2022.....	25
	FIGURES	
	Figure 1 Site Context Plan	
	Figure 2 Construction Access Route	

FOR DISCHARGE

1. INTRODUCTION AND SCOPE

1.1 Project Overview

1. East Anglia Three Limited (EATL) was awarded a Development Consent Order (DCO) by the Secretary of State, Department of Business, Energy & Industrial Strategy (DBEIS) on 7 August 2017 for the East Anglia THREE Offshore Windfarm (EA THREE). The DCO granted consent for the development of a 1200MW offshore windfarm and associated infrastructure and is live until 28 August 2022.
2. The DCO has now been subject to three non-material variations:
 - In March 2019 EATL submitted a non-material change application to DBEIS to amend the consent to increase the maximum generating capacity from 1,200MW to 1,400MW and to limit the maximum number of gravity base foundations to 100. In June 2019 DBEIS authorised the proposed change application and issued an Amendments Order.
 - In July 2020 EATL submitted a second non-material change application to DBEIS to amend the parameters of its offshore substations (reducing the number of these to one) and wind turbines (a decrease in the number of turbines and an increase in their hub height and rotor radius). On 15 April 2021 DBEIS authorised this proposed change application and issued an Amendments Order.
 - In August 2021 EATL submitted a third non-material change application to DBEIS to amend the consent to remove the maximum generating capacity of 1,400MW and to amend the parameters of its wind turbines (a decrease in the number of turbines and an increase in their hub height and rotor radius). The application is currently in the consultation phase.
3. The onshore construction works associated with EA THREE will have a capacity of 1,400MW and transmission connection of 1,320MW. The construction works will be spread across a 37km corridor between the Suffolk coast at Bawdsey and the converter station at Bramford, passing the northern side of Ipswich. As a result of the strategic approach taken, the cables will be pulled through pre-installed ducts laid during the onshore works for East Anglia ONE Offshore Windfarm (EA ONE), thereby substantially reducing the impacts of connecting to the National Grid (NG) at the same location. The infrastructure to be installed for EA THREE, therefore, comprises:
 - The landfall site with one associated transition bay location with two transition bays containing the connection between the offshore and onshore cables;
 - Two onshore electrical cables (single core);
 - Up to 62 jointing bay locations each with up to two jointing bays;
 - One onshore converter station, adjacent to the EA ONE Substation;
 - Three cables to link the converter station to the National Grid Bramford Substation;
 - Up to three onshore fibre optic cables; and
 - Landscaping and tree planting around the onshore converter station location.
4. Since the granting of the DCO, the decision has been made that the electrical connection for EA THREE will comprise a high voltage direct current (HVDC) cable rather than a high voltage alternating current cable and, therefore, the type of substation that will be required is a HVDC converter station. The substation will be referred to here as a 'converter station' and this amended terminology has been agreed with the relevant authorities on 15 October 2020. It has also been determined that only one converter station will be constructed rather than two and that the converter station will be installed in a single construction phase.

1.2 Purpose and Scope

5. This Traffic Management Plan (TMP) sets out the standards and procedures for managing the impact of traffic during the construction works for the Paper Mill Lane Works Stage of the EA THREE onshore cable route works, to facilitate safe use of the existing road network. This document has been produced to discharge DCO Requirements 16 (3) and 27 (1) (c) which state:

Highway accesses and improvements

16. (3) *No stage of the connection works may commence until for that stage, a scheme of traffic management measures (in accordance with table 2 of the outline traffic management plan) has been submitted to, and approved by the relevant planning authority in consultation with the relevant highway authority. The scheme must describe whether the proposed measures are to be temporary or permanent.*

Traffic

27. (1) *No stage of the connection works may commence until for that stage the following have been submitted to and approved by the relevant local planning authority in consultation with the relevant highway authority—
(a) a traffic management plan which must be in accordance with the outline traffic management plan;*

6. The scope of this document relates to the TMP associated with the construction of the Paper Mill Lane Works Stage, as part of the onshore cable works, running from the landfall location at Bawdsey to the Converter Station works located near Bramford, Suffolk, comprising Work No.s 50 and 51 (Figure 1 Site Context Plan). Separate TMPs have been produced for each stage of the onshore connection works and are provided under separate cover.
7. The Paper Mill Lane Works will be some of the first works to be undertaken along the cable route. These works have been designated as a stage in their own right to allow the works to commence at this location prior to works commencing along the cable route as a whole (i.e. the main cable works construction phase). The Primary Construction Consolidation Site (CCS) and the access to it will be constructed in Summer 2022 and the additional access construction jointing bay installation, cable pull through and reinstatement will be undertaken as part of the main cable works construction phase.
8. The purpose of the TMP is to ensure that the traffic impacts of the development remain within those assessed by the Environmental Statement (ES). This TMP takes account of the route surveys, assessments and route evaluations undertaken and has been developed in accordance with the Outline Traffic Management Plan (Document Reference 8.7 of the DCO application) and Access Management Plan (EA3- GRD-CON-PLN-IBR-00023).
9. The cable works Principal Contractor shall manage all construction traffic in accordance with this Traffic Management Plan, the Access Management Plan (EA3- GRD-CON-PLN-IBR- 000023) and the Travel Plan (EA3-LDC-CNS-REP-IBR-000033). The measures contained herein will be adhered to by the Principal Contractor (and thereby all tiers of construction workforce) and implementation and compliance will be monitored by the Construction Management Team. These measures will only be revised with the agreement of the Local Highway Authority (SCC).
10. Mitigation to minimise noise or vibration impacts are set out in the Construction Noise and Vibration Management Plan (EA3-LDC-CNS-REP-IBR-000021). Management of dust emissions and management of Public Rights of Way (PRoW) are set out in the onshore cable works Code of Construction Practice (EA3-LDC-CNS-REP-IBR-000065).
11. EATL will work with the SCC to ensure appropriate resourcing is in place to monitor compliance with the provisions of this TMP.

2. ABBREVIATIONS

AADT	Annual Average Daily Traffic
CCS	Consolidated Construction Site
CLO	Community Liaison Officer
DBEIS	Department of Business, Energy and Industrial Strategy
DC	Direct Current
DfT	Department for Transport
DCO	Development Consent Order
DMRB	Design Manual for Roads & Bridges
EA ONE	East Anglia ONE Offshore Windfarm
EA THREE	East Anglia THREE Offshore Windfarm
EATL	East Anglia THREE Limited
ES	Environmental Statement

ESDAL	Electronic Service Delivery for Abnormal Loads system
HGV	Heavy Goods Vehicle
HVDC	High Voltage Direct Current
LAR	Local Access Route
MSDC	Mid Suffolk District Council
MW	Megawatt
NG	National Grid
PRoW	Public Rights of Way
SAR	Strategic Access Route
SCC	Suffolk County Council Local Highway Authority
SLR	Suffolk Lorry Route
TMP	Traffic Management Plan
TCo	Traffic Co-ordinator

3. CONSTRUCTION DETAILS

3.1 Cable Works – Overview

12. The construction works will be spread across a 37km corridor between the Suffolk coast at Bawdsey and the Converter Station at Bramford, passing the northern side of Ipswich. The cables will be pulled through pre-installed ducts laid during the onshore works for East Anglia ONE. The construction activity within each section along the onshore cable route will be as follows:
- Any minor temporary modifications to the public road network;
 - Establish the Construction Consolidation Sites (CCSs);
 - Establish accesses to, and temporary haul road to, the jointing bay locations;
 - Establish temporary jointing bay compounds;
 - Excavate jointing bay pit to locate the existing ducts at each of the compounds;
 - Construct jointing bay;
 - Transport of cables to site, pull cables through ducts and undertake jointing;
 - Topsoil replacement and seeding;
 - Remove temporary compounds (jointing bays and CCS); and
 - Reinstatement all disturbed land and permanent fences and hedges.
13. Some temporary modification of the existing road networks may be required such as localised widening, temporary widening or socketing of street signs and temporary moving of street furniture in order to allow larger vehicles than normal to access the jointing bays. This will be completed prior to the start of the main construction works within relevant sections of the cable corridor route.
14. EATL will require up to seven temporary construction compounds to aid in the construction of the proposed East Anglia THREE project. These have been designated as ‘Primary Construction Consolidation Site’ (PCCS) and ‘Secondary Construction Consolidation Site’ (SCCS) depending on their uses. Two PCCS and up to five SCCS will be installed, which will all be temporary and will be removed once construction is complete.

Table 3-1 – Construction Consolidation Site Locations

CCS Type	ID	Address
Secondary	A	Bullen Lane, Bramford, Ipswich, Suffolk IP8
Primary	B	Paper Mill Lane, Claydon, Ipswich, Suffolk IP6 0AP
Secondary	C	Witnesham Road, Ipswich, Suffolk IP6
Secondary	D	Playford Corner, Playford Mount, Ipswich, Suffolk IP6 9DS

CCS Type	ID	Address
Primary	E	Top Street, Martlesham, Suffolk IP12
Secondary	F	Clappits, Woodbridge Road, Newbourne, Woodbridge, Suffolk IP12 4PA
Secondary	G	Park Lane, Ipswich, Suffolk IP10

15. The PCCSs will:

- Form the main point of access onto the linear construction site;
- Provide areas for the storage of materials and equipment;
- House site administration and welfare facilities for the labour resources;
- Form an interchange hub for deliveries of material, equipment and resources; and
- Allow HGVs to park prior to entering the local road network during peak hours.

16. The SCCSs will act as hubs for the delivery of materials, equipment and resources along the route and will enable access to the cable route for construction. They will be of sufficient size to accommodate limited storage of materials, equipment and labour welfare facilities.

17. It is anticipated that 29 jointing bays will be required along the 37km cable route, in addition to a transition bay at the landfall. Each jointing bay will comprise a concrete box 10m long by 3m wide by 1.5m high buried so that the base is 2.5m below ground level. A jointing bay construction compound will be required adjacent to each jointing bay and will have hardstanding areas of up to 900m² within the compound which would typically measure 24m x 115m i.e. 2,760m². (in accordance with Requirement 12(11) which stipulates that the footprint must not exceed 3,740m²). The compounds will have hardstanding and accommodate containers, drum trailer movement, parking, and welfare. A typical layout is shown in Figure 2 of the Code of Construction Practice (EA3-LDC-CNS-REP-IBR-000065).

18. Existing accesses and farm tracks will be upgraded and used where possible to access the jointing bay locations. Once these accesses reach the cable corridor, the routes to connect to the jointing bays are referred to as 'haul road'. The length of haul road for the cable route is limited by Requirement 12(12) of the DCO to 18.05km.

19. In addition, the ducts to be used for EA THREE, which were installed during the EA ONE project construction works, will require to be 'proved' to ensure that they are intact and free of debris. This will be undertaken by the use of foam pigs which will be driven under pressure from jointing bay to jointing bay. Each stretch of duct that was installed using Horizontal Direct Drilling (HDD) will, however, require duct-proving excavations at each end of the HDD, to allow the use of different size foam pigs, due to a difference in the diameter of these compared to the ducting installed using open trench techniques.

3.2 Paper Mill Lane Works

20. Paper Mill Lane Works comprise a stage of the onshore connection works and cover Work No.s 50 and 51. The infrastructure within these work no.s comprises:

- The Paper Mill Lane PCCS in Work No. 51;
- Jointing Bay 4 in Work No. 50;
- Two new accesses with the public road (Paper Mill Lane) as follows:
 - Access AP-AF to the east of Paper Mill Lane, to access the PCCS and Jointing Bay 4; and
 - Access AP-AG to the west of Paper Mill Lane to access the ends of the HDD ducts;
- The access track/haul road required to access the PCCS and Jointing Bay 4;
- Two stretches of trackway to reach duct proving excavations at the ends of the HDD ducts in the Work No.s to the east and west of the Paper Mill Lane Works; and
- Turning circle and HGV parking area in Work No 51 to allow HGV movements to be safely coordinated.

21. These works are shown on Figure 1.

22. Paper Mill Lane PCCS and the two accesses from Paper Mill Lane were used as part of the EA ONE construction works and have now been reinstated, other than part of the access to the east which has been partially reinstated, and so will need to be constructed again under the EA THREE DCO. There are no public rights of way within the site.

3.2.1 Accesses AP-AF and AP-AG, Access Track, Haul Road and Trackway (Work No. 50)

23. Paper Mill Lane PCCS and the Jointing Bay will be accessed from Paper Mill Lane using Access AP-AF. This access was used for the EA ONE project and has now been partially reinstated. Planning permission has been granted for the access that remains (Reference DC/20/05669). From Access AP-AF, a new temporary vehicular access track of 180m length and 5.5m width will be used to access the Paper Mill Lane PCCS and also reach the edge of the cable corridor (Work No. 50), where 90m of 5.5m wide haul road will link to the jointing bay. From here, 140m of 5.5m wide trackway will be installed to reach the excavation point on the HDD ducts in Work No. 49. Of this trackway, 90m will be within Work No. 49 and is not part of the Paper Mill Lane Works.
24. An access (Access AP-AG) will also be required on the west side of Paper Mill Lane, along with a 185m length of trackway to reach the proposed HDD duct proving excavation in Work No. 52 during the main cable works. Only 33m of this trackway will be within the Paper Mill Lane Works.
25. No watercourse crossings will be required for the Paper Mill Lane Works.
26. The construction methodologies associated with the access, access track and haul roads are typically as follows:
- Set out the access and track/haul road with the use of Global Positioning Systems (GPS) Real Time Kinematic (RTK) equipment;
 - Locate, divert and cap any existing field drains;
 - Set out and install drainage features the length of track to be constructed;
 - Remove vegetation, then remove and locally store topsoil material over the working width; seeding topsoil if it is to be stored for longer than 6 months;
 - Excavate to formation level and store any excess material;
 - Under-track drainage will be installed where necessary and in accordance with drainage requirements;
 - Place a geotextile onto existing subsoil to improve the bearing capacity of the sub-soil, depending on ground conditions, programme and landowner requirements;
 - Place imported stone in accordance with the design to form the track structure; and
 - For the trackway, following the setting out of the route using GPS RTK, the trackmatting would be installed directly on the existing ground surface.

3.2.2 Primary Construction Consolidation Site (Work No. 51)

27. The Paper Mill Lane PCCS (CCS B) will be a designated storage and delivery facility and also the main administrative compound for the onshore cable works. The dimensions of the PCCS at Paper Mill Lane will be 90m long by 40m wide covering a surface area of 3,600m², this is in accordance with Requirement 12(9)(a) which limits the size of each PCCS to 3,600m². The Paper Mill Lane PCCS will also be within the area previously used for the EA ONE PCCS in this location.
28. The construction of the PCCSs involves stripping of topsoil, importing and laying stone for the compound base and installing cabins and welfare facilities. Construction of the Paper Mill Lane PCCS will take approximately 3 weeks and the methodology will be as follows:
- The extent of PCCS will be marked out with the use of GPS RTK equipment;
 - Any existing field drains will be located, diverted and capped;
 - Drainage features will be set out and installed as required;
 - Security fencing will be erected around the perimeter of the PCCS;
 - Once vegetation has been removed, topsoil material over the PCCS area will be removed and locally stored and seeded if it is to be stored for longer than 6 months;
 - Any excess material will be excavated to formation level and stored; and
 - Imported stone will be placed in accordance with the design of the PCCS base structure.
29. An HGV queuing area (195m²), turning circle (303m²) and parking up area (447m²) will also be required adjacent to the PCCS. This will enable a key part of the EA THREE traffic strategy which requires any HGVs arriving via the strategic road network during peak hours to park up at the Primary CCS, as HGVs will only be permitted to enter the local road network during permitted delivery windows (generally 9am-4.30pm (see Table 6-2 of the Traffic Management Plan (EA3 LDC-CNS-REP-IBR-000039))).

30. The Paper Mill Lane PCCS will be constructed first in summer 2022, with the duct proving, jointing bay and cable pull through occurring at a later date (anticipated in 2024). It is intended that the PCCS will provide an early onsite presence for the onshore cable construction works and will be used as a base for mitigation and survey works being undertaken as well as for the construction team to visit site during the later stages of the planning and design process. It will also be used for stakeholder and other site meetings.

31. The Paper Mill Lane PCCS will remain in situ for the duration of the onshore cable works, prior to being restored as described in Section 3.2.4.

3.2.3 Jointing Bay 4 (Work No. 51)

32. The jointing bay will be located within Work No. 50, 150m to the south east of the PCCS at OS Grid Reference 613067, 248933.

33. Once the location of the jointing bay compound has been established (using GPS RTK equipment), creation of the compound will commence with erection of temporary security fencing, removal of topsoil layer and installation of hardstanding areas.

34. The jointing bay will then be excavated to a depth of up to 2.5m with adequate slope batter or shoring on all sides of the excavation to prevent the soil from collapse. The existing ducts will be uncovered and concrete slabs constructed to provide a level working area. Two sump pits will be included to facilitate drainage and dewatering and water will be treated, where necessary, before being discharged. Installation and jointing of the cables will then take place, along with installation of earthing link boxes and fibre optic cable chambers, before the area is back filled with subsoil.

35. The creation of the jointing bay compound and excavation of the jointing bay will each take a week.

3.2.3.1 Cable Installation

36. The electrical transmission cables will be delivered to the CCS, from where they will be transferred to the jointing bay compound when needed. The cable drums will comprise abnormal loads and their delivery will be managed as set out in the Traffic Management Plan (EA3-LDC-ONCS-REP-IBR-000032). Two cable lengths of approximately 1,260m will be required to pull through between each pair of jointing bays. The cable ducts will be proved before the cable is pulled through. Once the cables are received at the jointing bay compound, they will be temporarily stored on the hardstanding area prior to installation in the pre-installed ducts.

37. Installation of the cables into the ducts between Jointing Bay 4 and Jointing Bay 3 (not part of the Paper Mill Lane Works) will begin with a cable pulling system being installed into the bay. A steel bond and winching system with free spinning rollers will be installed along the bottom of the bay. Hydraulic jacks will raise the cable drum off the ground and a winch will be used to pull in cable using a pulling rope. A dynamometer will ensure the maximum pulling tension is not exceeded. Tension on the cable will be reduced using a biodegradable water-based lubricant. This process will be repeated for the second cable being installed in the duct. The cables will then be jointed once 2 cable sections (4 cables) have been installed.

38. It is expected that pulling and jointing operations would take approximately 2.5 weeks, typically spread over a three to four week period, with approximately five workers for each jointing bay. These works will then be repeated to install the cables between Jointing Bays 4 and 5.

3.2.4 Reinstatement

39. Following installation and jointing of the cables, the jointing bay, jointing bay compound, access and haul road will be reinstated with the stored topsoil and subsoil following trenching. If necessary, the subsoil will be 'ripped' prior to placement if compaction had occurred. Topsoil will be spread in such a way as to ensure that it does not become compacted. The topsoil will then be cultivated and reseeded (if required) and suitable hedgerow species replanted during the first appropriate planting season, in accordance with the Landscape Management Plan (EA3- LDC-ONCS-REP-IBR-000064). Temporary fencing around any new planting would be removed once reinstatement was established.

40. Trackway will be removed following installation of the cables in the adjacent Work No.s.

41. The PCCS will remain in situ for the duration of the cable works and will then be removed and reinstated as outlined above.

3.3 Temporary Infrastructure Access Locations

42. Table 3-2 presents the location and access details of the temporary construction works for the Paper Mill Lane Works (i.e. the PCCS and jointing bay and also the HDD excavation in Work No. 52). These will be accessed from the A14 (part of the Suffolk Lorry Route Network) via Junction 1 (the Claydon Interchange) onto Paper Mill Lane, as shown in Figure 2 Construction Access Route.

Table 3-2 Temporary Infrastructure Access Locations

ID	Address/Location	Easting	Northing	Access ID
Paper Mill Lane CCS	Paper Mill Lane, Claydon, Ipswich, Suffolk IP6 0AP	612843	249077	AP-AF
HDD (HDD-4)	Excavation Paper Mill Lane, Claydon, Mid Suffolk, Suffolk, IP8 4DE	612805	248970	AP-AG

3.4 Construction Traffic

3.4.1 HGV Movements

43. Chapter 27 Traffic and Transport of the ES for the East Anglia THREE project has assessed the environmental impact of traffic on the routes within the onshore highway study area across a range of effects, namely:

- Pedestrian amenity;
- Severance;
- Road safety; and
- Driver delay.

44. The assessment was predicated on a TMP being implemented as embedded mitigation that would manage the daily delivery profiles and control movements and routing. The ES included peak hour assessments (i.e. between 08:00-09:00 and 17:00-18:00) and gives details of the maximum peak hour HGV movements. The overall assessment concluded that appropriate TMP measures would ensure that the environmental impacts would not be 'significant', including with respect to driver delay, i.e. congestion on the highway network and junctions in proximity to the cable route.

45. Following further design works by the selected Cable Route Principal Contractor, (NKT) and also by the Principal Contactor for the converter station (Siemens Energy), an updated transport assessment (the scope for which is set out in paragraph 46) has now been carried out and is included in this document as Appendix 1 East Anglia Three Converter Station and Paper Mill Lane Works Traffic and Transport Technical Note (the Traffic and Transport Technical Note). The Traffic and Transport Technical Note provides an overview of the changes to the vehicle numbers associated with the construction of the Paper Mill Lane Works, the nearby cable works and also the Converter Station Stage in order to consider all project-related traffic on the road network to be used for the Paper Mill Lane Works.

46. The Traffic and Transport Technical Note sets out the following:

- A summary of the assessment assumptions and resulting vehicle numbers associated with the construction of the Paper Mill Lane Works, the Converter Station Stage and also relevant cable works as identified in the ES;
- A summary of the assessment of vehicular impact associated with the construction of these EA THREE works, on the highway network in the ES;
- A summary of the potential assessment requirements of vehicular impact associated with the construction of these EA THREE connection works on the highway network, following the issue of the DCO;
- A summary of the difference between the vehicle movements identified in the ES and the actual vehicle movements identified by NKT and Siemens Energy, based on a lower car occupancy (1.5) than presented in the ES (2.5), for a robust assessment;
- A summary of the anticipated total vehicle movements associated with the construction of these EA THREE works including the revised vehicle movements, at the locations potentially requiring assessment on the highway network;

- A review of the likely impacts at the sensitive junctions on the highway network that are likely to be used by traffic associated with the construction of the Paper Mill Lane Works and Converter Station Stage (including for relevant cable works).
- A junction capacity assessment is included of the identified sensitive junction (Junction 1: A14/B1113 Claydon Interchange) to test the impact of the confirmed EA THREE traffic data at this junction, using the most recent baseline traffic data available and incorporating vehicle movements associated with various committed developments. The assessment confirmed there would be no capacity issues at the junction with the addition of the EA THREE vehicle movements.
- A review of road safety on the routes that would be used by the construction traffic associated with the construction of the Paper Mill Lane Works, the Converter Station Stage and the relevant cable installation works (Sections 8 to 11) shows there are no road safety issues that would be exacerbated by an increase in traffic flows and that no additional traffic management measures are required.

47. The maximum daily and evening peak vehicle movements presented in Appendix 1 are summarised in Table 3-2. This is based on a car occupancy of 1.5, which has been identified from lessons learnt from the East Anglia TWO and East Anglia ONE North Offshore Windfarm’ Environmental Statements and DCO Examinations, advice from SCC and through discussions with NKT and Siemens Energy, who have suggested that a 2.5 car occupancy is unlikely to be achievable.

Table 3-2 Confirmed Maximum Figures (NKT and Siemens Energy)

	Employees				HGV Movements	
	Number		Vehicle Movements		Daily	PM Peak
	Daily	PM Peak	Daily	PM Peak		
Converter Station	130	130	174	87	68	8
Paper Mill Lane Works including relevant cable installation works (Sections 8 to 11)	60	60	80	40	20	2
	190	190	254	127	88	10

48. A Construction Access Route Assessment (371024-TRNS-REP-002, Rev 002) was undertaken prior to the construction of the EA ONE onshore electrical connection to evaluate the Local Access Routes of the construction road network, which do not form part of the Suffolk Lorry Route Network. The assessment included:

- An on-site engineering survey;
- An assessment and route evaluation of the construction access routes for the delivery of equipment, construction plant, materials; and
- The construction workforce along the Local Access Routes.

49. The assessment determined that the local access roads identified presented viable and safe routes for use by the EA ONE construction traffic over the duration of the onshore construction works, subject to the implementation of mitigating measures and temporary road improvements. A further route assessment has been undertaken for, *inter alia*, Paper Mill Lane Works by Fairhursts on behalf of NKT and is included as Appendix 2 (NKT UK, EA3 HVDC Route Works Transport Assessment, April 2022). The route assessment considered safe access arrangements, the use of passing places and the requirements for advance warning signage, together with any weight restrictions, and any obstructions which may compromise the transportation of equipment. This confirms the suitability of the route between Access AP-AF and Access AP-AG and the main road network (i.e. the Suffolk Lorry Route Network) such that no highway improvements are required. .

3.4.2 Abnormal Load Movements

50. The installation of the cables at the Playford Corner Works will require the delivery of 4 cable drums to the Paper Mill Lane PCCS. Due to their weight (likely to be in excess of 50 tonnes), these deliveries will comprise Abnormal Indivisible Loads (AIL) (either

Category 2 or Category 3). These will be delivered via specialist means and offloaded for example by the use of a mobile crane (see Sections 6.3 for details of abnormal load transport procedures).

51. Timing and notice periods for abnormal load deliveries will be agreed with SCC and Highways England in reasonable time (i.e. 6 months). The Principal Contractor will also confirm with Suffolk Highways Structures Team that the structures along the routes to be used have not deteriorated and are suitable for the proposed loads. Delivery of AIL will be undertaken in consultation with Suffolk Constabulary. Post construction surveys of the public roads and follow up reinstatement will be undertaken and agreed with SCC to ensure that any damage is remediated.

4. TRAFFIC MANAGEMENT PLAN GOVERNANCE

52. Prior to the commencement of construction, a Traffic Co-ordinator (TCO) will be appointed by the Principal Contractor for the onshore cable route. EATL Construction Team will have ultimate responsibility for overseeing that Principal Contractors management of the works are in accordance with the RDDs. The TCO's key responsibilities will include:

- Managing the implementation of and compliance with the TMP, Access Management Plan and Travel Plan;
- Reporting on a quarterly basis to MSDC and SCC with respect to these plans and their monitoring targets; and
- Acting as a point of contact for construction workers and sub-contractors.

53. Contact details for the TCO (and any subsequent personnel changes) will be submitted to stakeholders for their records prior to commencement of construction.

5. LOCAL COMMUNITY LIAISON

54. EATL is committed to providing clear communication to local residents and will manage public relations with local residents and businesses that will be affected by construction traffic. Proactive community liaison will be maintained, keeping local residents informed of the type and timing of works involved, the transport routes associated with the works, the hours of likely construction traffic movements and key traffic management measures. As outlined in the Code of Construction Practice (EA3-LDC-CNS-REP-IBR-000065), a combination of communication mechanisms such as posters, notices, exhibitions, letters, newsletters, website updates and parish council meetings will be employed to keep local residents and businesses informed.

55. A designated EA THREE Community Liaison Officer (CLO) will manage and respond to any public concerns, queries or complaints in a professional and diligent manner as set out in the Community Liaison and Public Relations Procedure contained within the Code of Construction Practice (EA3-LDC-CNS-REP-IBR-000065). The Complaints Procedure will be publicised and complaints will be directed to the EATL Community Liaison Officer. All enquiries will be logged, investigated and rectifying actions taken when deemed appropriate. Enquiries will be dealt with in an expedient and courteous manner. Details of complaints will be reported to Mid Suffolk District Council (MSDC) and SCC within 48 hours.

56. The CLO will liaise with parish councils to identify any local activities that may overlap with the construction works. EATL's Land Team will also speak to landowners regarding the timing of harvest and agricultural activity.

57. Parish Councils, District Councillors and County Councillors including Ward Members and Portfolio Holders, in the area and the local liaison group will be contacted (in writing) in advance of the proposed works and ahead of key milestones in order to advise them of the ongoing works. The information provided will include a timetable of works, a schedule of working hours, the extent of the works, and a contact name, address and telephone number in case of complaint or query.

58. All transport related to the construction of the EA THREE cable, including the Paper Mill Lane Works, will be registered and issued with a unique vehicle identification code. This will be included on an identification sticker/board that will be placed in a prominent position on the vehicle to enable the site management team and members of the public to identify the vehicle and its association to EA THREE. This will be monitored by the TCO (see Section 4). This scheme shall be submitted to and approved by SCC. Details of the scheme will also be shared with MSDC. SPR construction vehicles will have a defined identification livery so that they are immediately identifiable to construction staff and third parties.

6. TRAFFIC MANAGEMENT MEASURES

6.1 General Principles

59. Where consented, existing points of access situated close to each jointing bay location will be utilised, as is the case for the jointing bay at the Paper Mill Lane Works.
60. The traffic management strategy is predicated on using the most efficient payload vehicle for delivery of materials (e.g. 20 tonne payload for stone deliveries) and therefore negates the need to downsize to smaller vehicles and double handle materials, minimising potential HGV movements on the highway network.
61. During consultation, the public expressed concerns with regard to highway improvements, fearing large over designed solutions which would look out of character with the surrounding landscape causing irrevocable environmental impacts. With this in mind, all highway solutions have taken a sensitive approach and hard engineering methods have been minimised to reduce impact on the surrounding environment.
62. There are no schools in close proximity to the Paper Mill Lane Works HGV route and therefore measures to minimise impacts with regards to these are not proposed. In addition, no road closures are anticipated with respect to the Paper Mill Lane Works. Should it be identified that a road closure may be of less disruption or a safer option to public and workforce, then installation and timescales will be agreed with SCC Highways Authority and installed in line with the Traffic Noticing Requirements.
63. Compliance with the following measures will be subject to monitoring and enforcement measures set out in Section 7.

6.2 HGV Route Assessment

64. The updated transport assessment (Appendix 1) and route assessment (Appendix 2) have examined the appropriateness, viability and justification for the use of the existing transport networks available to ensure any impact of the additional delivery and transport movements of the Paper Mill Lane Works are minimised to an acceptable level. The outcome of these assessments established that the proposed construction route (as used by EA ONE) will adequately provide the requirements of the construction logistics.
65. The updated route Assessment (Appendix 2) confirms that from the A14 distributor route to access points AP-AF and AP-AG, the route is sufficiently wide enough to accommodate two vehicles passing each other. Therefore, no mitigation is required other than full reinstatement of the left turn filter lane into AP-05, as per the previously approved scheme constructed as part of the EA ONE project. Highway widening, the installation of passing places or the use of pilot vehicles will not be required.
66. The updated transport assessment (Appendix 1) confirms that there would be no capacity issues at the identified sensitive junction (Junction 1: A14/B1113 Claydon Interchange) with the addition of the EA THREE vehicle movements and that there would be no safety issues associated with the proposed route.
67. Temporary direction and warning signs to advise of construction vehicles will be provided in accordance with the Traffic Signs Manual, Chapter 8, Traffic safety measures and Signs for Road Works and Temporary solutions, Parts 1 and 2, commonly referred to as Chapter 8.

6.3 Abnormal Load Route Assessment

68. A detailed abnormal load route study (Appendix 2) has been undertaken by the Principal Contractor for agreement with SCC Highway Authority and police and has confirmed that the proposed AIL route is suitable without the need for highway improvements. Deliveries of the 4 AIL will be scheduled to minimise delay on the highway network such that driver delay effects associated with AILs are not likely to be significant. The 4 cable drum AILs will, however, comprise low loaders that will travel at speeds of approximately 40-50mph on the A149 and 30mph on Paper Mill Lane. Driver delay is not, therefore anticipated.
69. The movement of abnormal loads will be outside of the restrictions (routes and times) contained within this TMP with respect to HGVs and will be subject to separate agreement with the relevant highway authorities and police through the Electronic Service Delivery for Abnormal Loads (ESDAL) system. The TCo will notify stakeholders through ESDAL and agree appropriate timings, routes and asset protection measures (with the relevant highway authorities, police and Network Rail) appropriate to the type of load.

70. The timings and notice periods for all AIL deliveries will be agreed with SCC Highway Authority in advance in reasonable time and will be scheduled outside peak hours on the highway network. MSDC will also be notified of the timings of the AIL deliveries. Abnormal loads are not thought to be necessary for movements between Primary and Secondary CCSs.
71. Pre and post AIL movement condition surveys and follow up reinstatement will be undertaken to ensure that any damage is remediated.

6.4 Routing

72. The following measures will be implemented:
- a. All contractors will be contractually required to comply with the Paper Mill Lane Works HGV route as assessed and agreed with SCC through this TMP.
 - b. For the main cable works construction phase, all HGV deliveries will be made to the PCCSs with onward transfer to SCCSs using vehicles suited to the local network (PCCS B (Paper Mill Lane) will transfer on to CCCS A, C and D. PCCS E (Top Street) will transfer on to CCS D, F and G). There will also be transfer of materials between the two Primary CCS. However, during the initial construction of the Paper Mill Lane PCCS (and before the installation of the haul road, joint bay and cable pull through) all vehicles will travel directly to site.
 - c. The delivery routes will be communicated by the TCo to all companies and/or drivers involved in the transport of materials and plant to and from site by HGV construction vehicle.
 - d. Appropriate signage will be installed to direct suppliers and contractor's vehicles along the required route. Information signs will also be erected which will include a telephone number for the public to report concerns.
 - e. No construction HGVs are to be routed through: Coddenham; and Sproughton; to the south of Sandy Lane (south of Woodbridge) under the railway bridge; Westerfield (i.e. along Lower Road and Church Lane) or be permitted south of the entrance to CCS B on Paper Mill Lane. Appropriate prohibition signs will be installed at strategic locations to prevent construction vehicles entering these areas.
 - f. Where possible the contractor will use local suppliers to reduce the distance travelled on the wider highway network.
 - g. Compliance with the defined Paper Mill Lane Works HGV route will involve a vehicle registration system and log. The information will be made available to SCC upon request.
 - h. All HGV deliveries to the CCS will be of a size and appropriate weight to accord with the hierarchal structure of the SCC Lorry Route Network for Strategic, Zone Distributor and Local Access lorry routes.
 - i. Time restrictions will be placed on the transfer of materials and plant between all Primary and Secondary CCSs in order to avoid the busiest peak traffic hours (08:00-09:00 and 17:00-18:00).
 - j. The Principal Contractor will establish a line of communication with SCC's Emergency Planning Officer and Traffic Manager. If notified of a major incident obstructing the highway the contractor would liaise directly with suppliers to suspend HGV deliveries along affected routes. The contractor will liaise with SCC to identify and assess alternative temporary access arrangements.
 - k. The TCo will be aware of major events on the highway (e.g. bike races, parades, etc) and around public holidays and be responsible for managing traffic demand during such times. The TCo will liaise with local stakeholders to understand when major events may occur. A stockpile of materials will enable advanced planning to ensure there are limited HGV movements during planned major events whilst not impacting upon the construction programme.
 - l. Consideration will be given to the need for additional traffic measures at particular pinch points where HGVs cannot pass in opposing directions.
 - m. Consideration will be given to the size of vehicles appropriate to each section of the access routes.
73. Access route will be designated for deliveries to each SCCS from the Paper Mill Lane PCCS (CCS B), ensuring that only those roads adequate to carry construction traffic are used for that purpose. Up to 5 SCCS have been consented via the DCO. The use of the SCCSs will be confirmed in the Cable Traffic Management Plan. The routes between Paper Mill Lane PCCS and the selected SCCS will also be considered and set out in the Cable Traffic Management Plan.
74. Table 6-1 details the anticipated designated traffic routes to be used for movements to the Paper Mill Lane PCCS and routes for secondary movements from the PCCS to SCCS. These apply only to the main cable construction phase (including the installation of the haul road, joint bay and cable pull through for the Paper Mill Lane Works), rather than to the initial construction of the Paper Mill Lane PCCS as the other infrastructure will not be in place. These routes were used during the EA ONE construction works and will be confirmed in the Cable Traffic Management Plan prior to the commencement of the main construction phase.

Table 6-1 CCS Designated Traffic Routes for the Main Cable Construction Phase

CCS	From- To	Designated Route Details	Approx. mileage
A Secondary	CCS B to CCS A	Along Paper Mill Lane, LAR, to junction 1 A14 roundabout. Left onto B1113 Loraine Way/Bramford Road, SLR. Continue approx. 2 miles to Bullen Lane junction. Turn right onto Bullen Lane, LAR. Continue 1 mile along Bullen Lane to CCS A Bullen Lane on left hand side.	3.5
C Secondary	CCS B to CCS C	Along Paper Mill Lane, LAR, to junction 1 A14 roundabout. Right onto A14 Ipswich/Colchester, SAR. Travel 1 mile to junction 53. Take 1st exit to A1156 Bury Road, LAR. Proceed to second roundabout and take 2nd exit A1156 Bury Road, LAR, leading onto Norwich Road (height limit 4.1m) ¹ . Continue on Norwich Road for approx. 4miles. At roundabout take 1st exit onto A1214 Valley Road, LAR. Continue along A1214 Valley Road for approx. 1.2 miles to roundabout. Take 1st exit onto B1077 Westerfield Road, SLR. Continue along B1077 Westerfield Road 10 miles to CCS C on left hand side. (Route to be confirmed as part of the Cable Traffic Management Plan, should CCS C be used)	17
D-Secondary	CCS B to CCS D Option 1 – HGV Route	Along Paper Mill Lane, LAR, to junction 1 take A14, SAR, heading for Woodbridge. Follow to junction 58 and take A12, SAR, heading towards Woodbridge. At B1079 take first left – Grunisburgh & Hasketon, SLR. Follow Woodbridge Road B1079, SLR, and turn left through Grundisburgh following on to The Street, Rose Hill and Ipswich Road through Grundisburgh. Follow the road through Culpho to a right turn at Grundisburgh Road leading through to the junction of Church Lane. CCS D is on the right hand side 100yds before the Church Road junction. (Route to be confirmed as part of the Cable Traffic Management Plan, should CCS D be used)	47
D-Secondary	CCS B to CCS D Option 2 – Vans and Light vehicles only	Along Paper Mill Lane, LAR, to junction 1 A14 roundabout. Right onto A14 Ipswich/Colchester, SAR. Travel 1 mile to junction 53. Take 1st exit to A1156 Bury Road, LAR. Proceed to second roundabout and take 2nd exit A1156 Bury Road, LAR, leading onto Norwich Road. Continue on Norwich Road for approx. 4miles. At roundabout take 1st exit onto A1214 Valley Road, LAR. Continue along A1214 Valley Road for approx. 1.2 miles to roundabout. Take 1st exit onto B1077 Westerfield Road, SLR. Continue along B1077 Westerfield Road 16 miles to junction with B1078. Turn Right onto B1078, SLR, and travel approx. 2.7 miles to the junction with the B1077. Turn Right onto the B1079, SLR, following signs for Grundisburgh for 8 miles. Turn Right staying on B1079 at the junction of Mill Hill. Travel along B1079 for approx. 0.3 miles to junction with Woodbridge Road. Turn right onto Woodbridge Road, LAR, following on to The Street, Rose Hill and Ipswich Road through Grundisburgh. Follow the road through Culpho to a right turn at Grundisburgh Road leading through to the junction of Church Lane. CCS D is on the right hand side 100yds before the Church Road junction. (Route to be confirmed as part of the Cable Traffic Management Plan, should CCS D be used)	28

Abbreviations:

SAR - Strategic Access Route

SLR - Suffolk Lorry Route

LAR – Local Access Route

¹ Note – The use of CCS C will be confirmed as part of the cable design works, and height limitation considered further at that time

75. Appropriate signage will be installed to direct suppliers and contractor’s vehicles along the designated routes. This is to minimise the impact of deliveries on local residents and also minimise the risk of construction traffic missing vital junctions and not being able to turn round easily in the downstream road network. A review of signage locations will be undertaken with SCC Highways to ensure their suitability. Signage locations will be continually reviewed and agreed with SCC Highways during the entire construction phase.

76. A Construction Phase Traffic Management Plan will be produced in line with this TMP which will detail the requirements of all construction traffic. The Construction Phase Traffic Management Plan will detail all on site and off site traffic movements and management conditions for all traffic, plant and personnel associated with the project.

6.5 Crossing Points

77. The locations and method of crossing each highway, private track and PRoW by the proposed cable route works has been previously identified in the DCO in Schedule 2 and Schedule 3. No such crossing points are present within the Paper Mill Lane Works.

6.6 Delivery Times

78. To control delivery times and routes to the proposed East Anglia THREE project, all HGV traffic will be required to first report to either Paper Mill Lane PCCS or Top Street PCCS before then transferring to their respective points of access. Once HGVs have made their deliveries they would then return to the original origin of their journey rather than back to the Primary CCSs. This would apply only to the main cable construction phase (including the installation of the trackway, haul road, jointing bay and cable installation for the Paper Mill Lane Works), rather than to the initial construction of the Paper Mill Lane PCCS.

79. HGVs would be permitted to arrive at the Paper Mill Lane CCS between 8am and 6pm. To manage the impact of deliveries from the PCCS to the points of access (and back from the points of access to their original origin) deliveries would be scheduled to avoid network peak hours (8am to 9am and 5pm to 6pm). In addition, for some of the most sensitive links, the ES identified that there would also be a requirement for deliveries to avoid school finish times (typically 3pm to 4pm). However, this is not relevant to the Paper Mill Lane Works.

80. Table 6-2 summarises the times at which deliveries will be permitted, the table also includes an allowance for the travel time from the points of access back to the strategic highway network.

Table 6-2 HGV Delivery Windows

Delivery to Primary CCS		Delivery to point of access		Return to wider Network
Destination	Delivery window	Access ID	Onward delivery movement permitted from Primary CCS*	Return movement permitted from Point of Access*
B – Paper Mill Lane	8am – 6pm	AC, AD	9:00am – 4:30pm	9:00am – 4:30pm
		AE	9:00am – 2:45pm	9:00am – 2:45pm
			4:00pm – 4:45pm	4:00pm – 4:45pm
		AH-AL	9:00am – 4:45pm	9:00am – 4:45pm

*Permitted delivery windows

81. In addition to avoiding peak hours and sensitive hours for particular routes the Principal Contractor will establish a line of communication with SCC’s Emergency Planning Officer and Traffic Manager. If notified of a major incident obstructing the highway the Principal Contractor would liaise directly with suppliers to suspend HGV deliveries along affected routes.

82. If the obstruction is likely to be longer term, in the first instance the programme would be reviewed to ascertain if resource could be diverted to an alternative onshore cable route section. Failing that, the contractor would liaise with SCC to identify and assess alternative temporary access arrangements.

83. The Principal Contractor will also work closely with the local liaison groups to identify the dates of local planned events, e.g. harvests that could impact upon the project and seek to effectively manage deliveries during these events.

6.7 Training

84. All regular HGV construction vehicle drivers will be formally inducted to the proposed East Anglia THREE project. The induction will seek to establish a clear set of responsibilities that drivers will be required to follow and will include details of the following:
- a. Timings, pre-booked slots;
 - b. The approved HGV routes;
 - c. Highway safety concerns;
 - d. Adherence to speed limits;
 - e. Additional safe working practices where access routes use PRow or cycle routes;
 - f. Requirements for reporting accidents and 'near misses';
 - g. A Driver Code of Conduct;
 - h. Procedures for dealing with emergencies; and
 - i. Disciplinary measures for non-compliance.
85. An information pack will be distributed to all individuals involved in the transport of materials. The pack will be a convenient size so it can be stored in a truck cab. The pack will include the key information as described with respect to induction.
86. Any HGV construction vehicle driver not inducted and not regularly delivering to the proposed East Anglia THREE project will be issued with a Driver Code of Conduct and approved delivery route plan.

6.8 Control of HGV Numbers

87. The following measures will be implemented in order to minimise HGV movements:
- a. The Principal Contractor will be responsible for managing the demand for deliveries and exports for their own fleet and that of their supply chain partners to ensure they comply with agreed daily traffic profiles contained within the updated transport assessment (Appendix 1). A timed delivery booking system will be implemented. The proposed delivery schedule will be prepared weekly in advance by the Principal Contractor, taking into account other committed developments and seasonal variations, with limited spaces reserved for short notice deliveries. The planning of deliveries (via the booking system) will assist the Principal Contractor to allocate sufficient space within the temporary laydown area for the planned number of deliveries.
 - b. The Principal Contractor will be required to keep an up to date record of deliveries and exports from the Paper Mill Lane Works, this will take the form of delivery receipts. This information will be retained to be provided to SCC upon request.
 - c. The registration numbers for all HGVs making deliveries will be recorded by the TCo. This would allow for checking and enforcement of any reported breaches of the agreed delivery routes
 - d. In accordance with good construction practice, opportunities will be sought to reduce the overall number of HGV movements by consolidating loads and using the largest feasible vehicles taking into account any other environmental constraints that may affect HGV routes.
 - e. In accordance with the Code of Construction Practice (EA3-LDC-CSN-REP-IBR-0000065), the standard construction working hours for the Paper Mill Lane Works and any construction-related traffic movements in and out of the site will be between the following hours:
07:00 – 19:00 Monday to Friday; and
07:00 – 13:00 on Saturday.
There are a few exceptions to the above working times as defined in the DCO.
 - f. The TCo will be required to plan for maintaining stockpiles of critical path items such as aggregate. These stockpiles will facilitate advanced planning of deliveries, maximise payloads, and enable a smooth import profile to be maintained.

6.9 Signage

88. Appropriate signage will be installed to direct suppliers and contractor's vehicles along the Paper Mill Lane Works HGV route. This is to minimise the impact of deliveries on local residents and also minimise the risk of construction traffic missing vital junctions and

not being able to turn around easily in the downstream road network. A review of signage locations will be undertaken with SCC to ensure their suitability. Signage locations will be continually reviewed and agreed with SCC during the entire construction phase.

89. The Advance Warning signs to be installed shall include, but shall not be limited to:

- Information Signs, (including reference number, contact details, works to commence, proposed duration, diversionary routes);
- Works Access, directional and location (including No access to Unauthorised Persons - Construction Site);
- Construction traffic directional routing (e.g. EA THREE Access route (directional Arrows); No access to Construction Traffic, No HGV Beyond This Point);
- Road Works Ahead;
- SLOW – Workforce/obstructions in road ahead;
- New Layout Ahead;
- Changed Priorities;
- Pedestrian directions, crossings and directional;
- Temporary speed limits/restrictions – 30mph at all access points, crossing points and where straight line view is impaired by natural objects that cannot be removed due to environmental impact or engineering constraint. It is noted that despite the 30mph speed limit signs, not all drivers may reduce their speed accordingly. It is therefore proposed that road safety at the junction is continuously reviewed (for example through consideration of records of near misses) and if required, the need for further traffic calming measures will be agreed with SCC.; and
- Warning signs for any restrictions and/or obstructions that may be affected as a consequence of the works.

90. All temporary (and where agreed, permanent) traffic signs and road markings will be provided in accordance with the Traffic Signs and General Directions 2016 (DfT, 2016) and Chapter 8 'Traffic Safety Measures and Signs for Road Works, Temporary Situations' of the Traffic Signs Manual (DfT, 2009a and DfT. 2009b), in agreement with SCC (via Temporary Traffic Regulation Order applications) and Highways England (for works on A14). All temporary signage will be removed on completion.

6.10 Pre and Post Construction Surveys

91. Prior to the commencement of the construction works, pre-condition surveys (dilapidation surveys) of the Paper Mill Lane Works HGV route will be agreed with and undertaken in conjunction with SCC in accordance with the UK Pavement Management System standard. The survey will most likely comprise a Coarse Visual Inspection survey with more detailed surveys (such as the use of Deflectograph) for specific areas. The exact specification of surveys required would be agreed with SCC prior to commencement.

92. The pre-construction survey will also identify road surface irregularities which require remediation prior to construction in order to mitigate vibration impacts.

93. Costs of remedial works required as a result of construction will be funded by EATL. Further detail on the mitigation regarding vibration impacts will be outlined in the Construction Noise and Vibration Management Plan (EA3-LDC-CNS-REP-IBR-000021).

94. Any damage to the existing road network, street furniture as a consequence of the construction activities will be made good to the satisfaction of SCC, in accordance with such requirements (as to specification of materials and standard) as prescribed by regulations under the New Roads and Street Works Act 1991 (as amended).

95. The post-construction surveys and measures to secure any subsequent remediation will be agreed with SCC. These shall be undertaken as soon as possible on completion of relevant works.

96. The two surveys will form the basis of any ameliorating works that may be required upon completion of the onshore works, to rectify specific damage to the local road network as a direct result of the construction works. These pre and post construction surveys will include photographic records of street furniture and road conditions.

97. SCC will be kept updated of proposed start and completion dates via regular meetings and programme updates.

6.11 Additional controls

98. No daytime or overnight parking of site or construction vehicles (site employees or visitors) outside of the PCCS or jointing bay compound will be allowed without the prior agreement of SCC.

- 99. All traffic management measures will be temporary including traffic signs, road markings, barriers, lamps, traffic control and other such measures necessary in accordance with best practice unless otherwise agreed with the SCC. These will be installed and maintained in good condition throughout the extent of the construction period.
- 100. On-site wheel wash provisions shall be provided at appropriate access points connecting the cable works to the public highway. Off-site road cleansing/sweeping provision along sections of the public highway will be used by construction vehicles shall be to the satisfaction of SCC. The wheel washing facilities will be designed and located to avoid used water running onto the highway.
- 101. The Principal Contractor and its suppliers’ fleets will have arrangements with recovery companies to allow breakdowns and accidents to be cleared as quickly as possible in order to avoid any such incidents blocking the highway. All breakdowns and accidents will be reported to the TCo.

7. HIGHWAYS AND ACCESS IMPROVEMENTS

7.1 Highways Improvements

- 102. As noted in Section 6.2, an updated construction route assessment (Appendix 2) has examined the appropriateness, viability and justification for the use of the existing transport networks. This study identified that no highways improvements are required to enable safe access to the Paper Mill Lane Works.

7.2 Access Improvements

- 103. The proposed access arrangements are also given within the Access Management Plan and are summarised in Table 7-1.

Table 7-1 Summary of Access Improvements

Access ID	Location	Used on EA ONE?	Access Improvement	Traffic Management During Improvement	Traffic Management During Construction Phase
AP-AF	Paper Mill Lane	Yes –now has planning permission to be a permanent access	Installation of New Bell Mouth and full reinstatement of the left turn filter lane	Lane Closure Two Traffic Signals	Installation of Advanced Warning Signs
AP-AG	Paper Mill Lane	Yes -however this junction has been fully removed and will require to be fully reinstated to the same standard as previously approved under EA ONE	Installation of New Bell Mouth	Lane Closure Two Traffic Signals	Installation of Advanced Warning Signs

7.3 Traffic Appraisal

- 104. This TMP takes into account the safety implications along all ‘C’ and ‘U’ class roads where the width of the existing road is insufficient to accommodate the safe passage of two vehicles.
- 105. All local access routes that are to be used for the passage of works vehicles will be inspected in collaboration with SCC.

8. MONITORING AND ENFORCEMENT

8.1 Monitoring

106. The following section sets out how the targets and measures contained within this TMP will be monitored to ensure compliance.

8.1.1 HGV Numbers

107. The HGV movements associated with the Paper Mill Lane Works, including inter-site movements, will be continuously monitored by the TCo through the use of the Booking System to ensure adherence with the assessed HGV movements.

108. The information, i.e. records of deliveries and return journeys together with any breaches of the agreed delivery routes or delivery hours, will be made available to SCC on a quarterly basis, for checking against the application profile.

8.1.2 HGV Routing

109. The vehicle identity system (See section 5) will help the public distinguish HGV construction vehicles associated with the proposed East Anglia THREE project from other traffic on the highway network. Each HGV will be required to display a unique identifier, provided by the TCo within the window of the cab that will allow members of the public to report any concerns such as driver behaviour or the use of unapproved routes via a publicized telephone contact number. Signs will be erected at the construction access with the relevant contact number clearly displayed for public enquiries.

110. The TCo will be the first point of call for all concerns raised. Contact details will be made available in a regular newsletter that will be circulated to all local Parish and Town Councils and stored at community hubs, such as libraries, for reference.

111. The Principal Contractor will also ensure that where its HGV fleet is fitted with a GPS tracking system, that these are used to record the routes, time speed of vehicles when making deliveries. The GPS tracking together with delivery records will serve to augment the unique identifier to allow the TCo to respond to any complaints and provide a complete evidence base. The TCo will also ensure that where installed, these monitoring systems are activated, and records are made available to the TCo to facilitate auditing and complaint investigation.

8.2 Enforcement

8.2.1 Introduction

112. The consequences of not complying with the measures contained within this TMP could result in an increase in HGV traffic on the highway network and road safety concerns, potentially impacting on sensitive receptors, leading to significant environmental effects. It is therefore essential that the TCo can quickly react to any breaches and implement corrective processes. This section therefore provides a summary of the mechanisms that would ensure that the TMP is effectively enforced.

8.2.2 Potential Breaches

113. To ensure that the TMP can be effectively enforced it is important to define what would constitute a breach. The TMP therefore considers that the following would constitute a breach whereby corrective measures would be required:

- a. Failure to implement or use the agreed traffic management measure;
- b. Failure to follow the agreed delivery routes;
- c. Failure of the HGV to display its unique identifier;
- d. Construction HGV traffic operating outside of agreed hours;
- e. Exceeding the agreed freight and delivery profiles as set out within the updated transport assessment (Traffic and Transport Technical Note Appendix 1);
- f. Construction HGV traffic being driven inappropriately, e.g. speeding; and
- g. Failure to record deliveries and departures for plant and materials with the booking system.

8.2.3 Corrective Process

114. On receipt of a report of a potential breach, the TCo would investigate the circumstances and compile a report for MSDC and SCC Highway Authority within seven working days. The report would outline the outcome of the investigation and what corrective action

(if necessary) had been implemented. MSDC and SCC (as the Local Highway Authority) will then review the information, request further clarifications (if required) and confirm to the TCo if a material breach has occurred.

115. If the breach is found to be material, the following three stage process will be followed:
- Stage one – MSDC or SCC confirms a breach and requests Tco to review the data and concerns. MSDC, SCC and the TCo would then agree the extent of the breach of controls and agree action. This is likely to be a contractor warning at this stage;
 - Stage two – If a further material breach is identified the contractor would be given a further warning and required to involve individuals/sub-contractors/suppliers to produce an action plan to outline how the issue would be rectified and any additional mitigation measures proposed. The action plan should identify a strategy with a duration of not more than seven working days to correct the breach. MSDC and SCC will be informed.
 - Stage three – Should further breaches still occur the contractor would be required to remove the offender from site and the contractor/ supplier would receive a formal warning. Any continued breaches by individuals of the supplier/ contractor may be dealt with by the formal dispute procedures of the contract. MSDC and SCC will be informed.
116. Failure to follow the performance standards as shown in Section 8.2.2 and (including the correction process, or continued breaches would be addressed by contractual measures between EATL and the contractor.
117. Individual employee breaches will be addressed through UK employment law whereby the three stage process outlined will form the basis for disciplinary proceedings.

8.2.4 Action Plan

Table 8-1 TMP Action Plan

Measure	Timescale	Responsibility
Appointment of a TCo	Prior to construction commencement	Contractor
Implement advance warning signing	Prior to construction commencement	Contractor
Establish monitoring systems: • Delivering booking system; • Unique vehicle identifier system; and • Telephone reporting system.	Prior to construction commencement	TCo
Agree scope of highway condition surveys with SCC	Prior to construction commencement	TCo
Agree abnormal load restrictions with SCC through ESDAL	Prior to abnormal load movements	TCo
Monitoring of TMP measures: • HGV movements; • Accidents and near misses; • HGV monitoring; • Complaints; and • Produce monitoring reports.	Ongoing throughout construction	TCo

9. REFERENCES

DfT, 2009a, *Traffic Signs Manual, Chapter 8, Traffic Safety Measures and Signs for Road Works and Temporary Situations, Part 1: Design*. London, TSO

DfT, 2009b, *Traffic Signs Manual, Chapter 8, Traffic Safety Measures and Signs for Road Works and Temporary Situations, Part 2: Operations*. London, TSO

DfT, 2016, *DfT Circular 01/2016, Traffic Signs and General Directions 2016, Version 2*

SCC, 2017, *Suffolk Lorry Route Network*, <https://www.suffolk.gov.uk/assets/Roads-and-transport/lorry-management/Lorry-Route-Map-Amended-MAY-17.pdf>

FOR DISCHARGE

**APPENDIX 1 EAST ANGLIA THREE CONVERTER STATION AND PAPER MILL LANE
WORKS TRAFFIC AND TRANSPORT TECHNICAL NOTE**

FOR DISCHARGE

NKT UK

**EA3 HVDC Route
Commencement Works**

Transport Assessment

November 2021



NKT





**SCOTTISHPOWER
RENEWABLES**

FAIRHURST

CONTROL SHEET

CLIENT: NKT UK
PROJECT TITLE: EA3 HVDC Route, Commencement Works
REPORT TITLE: Transport Assessment
PROJECT REFERENCE: 146103
DOCUMENT NUMBER: 146103-DOC-02
STATUS: FINAL⁵

Issue & Approval Schedule			Name	Signature	Date	
	Prepared by	G Park			12/11/2021	
	Checked by	A Madden			12/11/2021	
	Approved by	S G Dickson			12/11/2021	
Revision Record	Rev.	Date	Status	Description	Signature	
	1	17/11/21	DRAFT 2	Design Team comments incorporated. Section 4 added in relation to Existing Services.	By	G Park
					Check	A Madden
					Approve	S G Dickson
	2	22/11/21	FINAL ¹	Section 3.4 relating to AP-W updated	By	G Park
					Check	A Madden
					Approve	S G Dickson
	3	23/12/21	FINAL ²	Drawings contained within Appendix 1 updated to take account of Red Line Boundary	By	G Park
					Check	A Madden
					Approve	S G Dickson
	4	11/03/22	FINAL ³	Reference to visibility splay dimensions updated	By	G Park
					Check	A Madden
					Approve	S G Dickson
	5	11/03/22	FINAL ⁴	Section 3.5 AP-H amendment to text	By	A Madden
					Check	G Park
					Approve	S G Dickson
	6	25/04/22	FINAL ⁵	Section 3.4 updated to reference the STOP/GO Method Statement. Appendix 2 added. All drawings contained in Appendix 1 updated.	By	G Park
					Check	A Madden
					Approve	S G Dickson

This document has been prepared in accordance with procedure OP/P02 of the *Fairhurst Quality and Environmental Management System*

This document has been prepared in accordance with the instructions of the client, NKT UK, for the client's sole and specific use. Any other persons who use any information contained herein do so at their own risk.

Contents

1.0 Introduction	1
2.0 Route Assessment	4
3.0 Access Junction Design & Public Road Crossings	9
4.0 Existing Services	14

Appendix 1 - Drawings

Appendix 2 - 146103-DOC-04 Method Statement for Traffic Control at Holly Lane

1.0 Introduction

1.1. Transportation Assessment Overview

Fairhurst has been appointed by NKT UK, on behalf of Scottish Power Renewables, to undertake an assessment of the transportation requirements associated with the commencement works for the East Anglia Three (EA3) cable installation project.

During construction of the East Anglia One project (EA1), ducts required for the future EA3 project were installed in the cable corridor from the landfall site at Bawdsey, to the new substation compound at Bullen Lane, Bramford. As part of the EA1 project, several sections of the existing local road network were upgraded to accommodate construction traffic, along with the construction of new access junctions into the cable corridor Construction Consolidation Sites (CCS). Improvement works included designated passing places and vegetation removal. On completion of the EA1 project, the majority the new access junctions were removed, however all of the passing places which were constructed on the local road network were retained at the request of Suffolk County Council.

This next phase of construction (EA3), will again require construction access into the cable corridor in order to re-establish various CCS compounds and sections of Haul Road, to facilitate access to the proposed Jointing Bay locations, to construct the Jointing Bays, and pull new cables through the previously installed ducts.

Several of the previously designed and approved access points which were constructed during the EA1 project will be re-instated to facilitate access, along with any new access points which were not part of the original scheme.

This document covers the assessment of the following commencement works:

Access Points:

- AP-F Paper Mill Lane (former AX-05 partially reinstated)
- AP-G Paper Mill Lane (former AX-04 reinstated)
- AP-H Newbourne Road (former AX-14 partially reinstated)
- AP-I Newbourne Road (New Access)
- AP-W Holly Lane (New Access)
- AP-X Playford (former AX-08 reinstated)

Public Road Crossing for the Haul Road:

- CR1 & CR2 (The Street, Newbourne)
- CR8 & CR9 (Church Road)

Route Assessment:

- B1079 at Grundisburgh, south towards AP-X, through to AP-W Holly Lane.

- A12 Roundabout west along Newbourne Road toward junction with Ipswich Road, then South along Newbourne Road towards AP-I and AP-H
- A14 Roundabout, southwards along Paper Mill Lane to AP-F and AP-G.

The location of the above commencement works is illustrated in Figure 1.

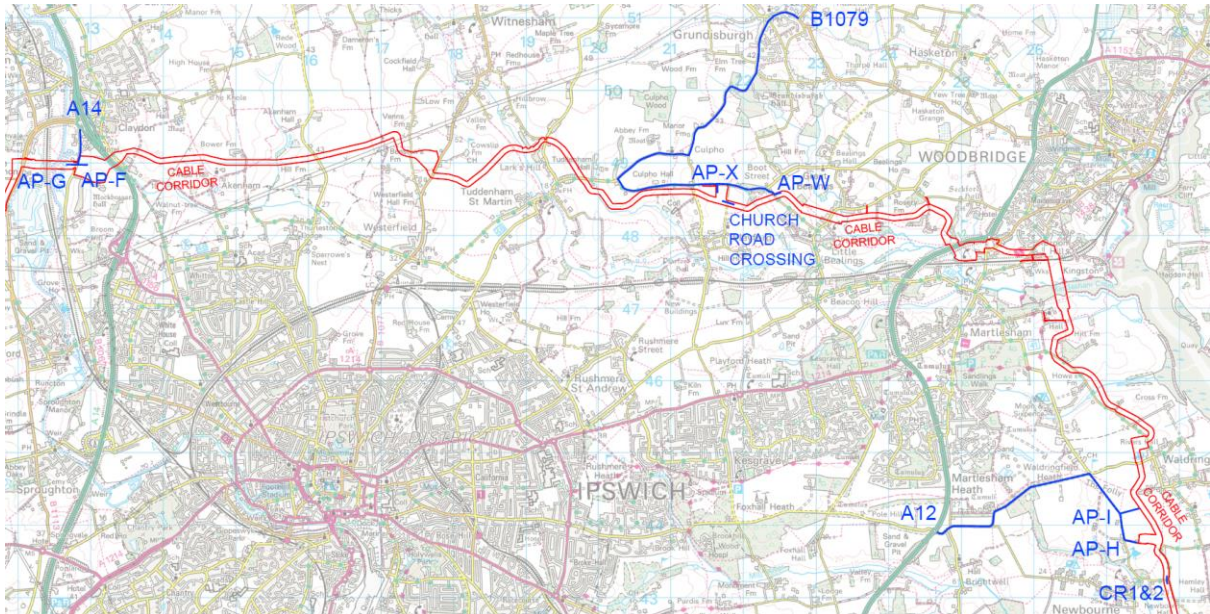
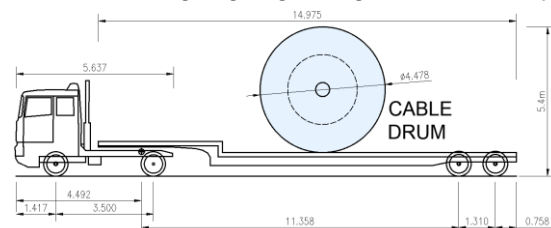

Figure 1: Location Plan

1.2. Scope of assessment

Route Assessment:

The proposed routes will be assessed from where they join the main road network, as indicated on the Suffolk Lorry Route Plan, along minor roads and towards each access point. The route assessment will consider safe access arrangements, the use of passing places and the requirements for advance warning signage, together with any weight restrictions, and any obstructions which may compromise the transportation of equipment. For the purpose of this assessment an articulated low-loader vehicle transporting a cable drum has been taken as the worst case scenario.



Access Point/Junction Design:

Two new access junctions will be designed. These are AP-I, located on Newbourne Road and AP-W, located on Holly Lane. Design of each new junction will take cognisance of the existing topography, existing vegetation, required visibility sightlines, and the minimum turning required to accommodate the low-loader vehicle.

A review of the previously installed access points used during the EA1 project will also be undertaken (AP-F, AP-G, AP-H, AP-X), along with the two areas where the proposed Haul Road will cross the public highway (CR1 & 2, and CR8 & 9).

1.3. Reference Documents

The findings of this report will be used as supplementary information to the following Scottish Power Renewables documents:

Table 1: Reference Documents

Document Reference	Title
EA3-LDC-CNS-REP-IBR-000023	Paper Mill Lane Commencement Works Access Management Plan
EA3-LDC-CNS-REP-IBR-000032	Paper Mill Lane Commencement Works Traffic Management Plan
EA3-LDC-CNS-REP-IBR-000036	Playford Commencement Works Access Management Plan
EA3-LDC-CNS-REP-IBR-000039	Playford Commencement Works Traffic Management Plan
EA3-LDC-CNS-REP-IBR-000050	Clappits Commencement Works Access Management Plan
EA3-LDC-CNS-REP-IBR-000053	Clappits Commencement Works Traffic Management Plan

2.0 Route Assessment

2.1. General Description

Three Access Routes have been assessed as part of this investigation. The location of each route is indicated on Figure 1, Section 1.1, and each route is described as follows:

1. From the roundabout at Junction 52 of the A14 to Access Points AP-F and AP-G.
2. From the junction of the B1079 & Woodbridge Rd to Access Points AP-X & AP-W
3. From the roundabout on the A12 at junction with Newbourne Road, to AP-H & AP-I

Each route provides access from the major road networks surrounding Ipswich, as identified on the Suffolk Lorry Route plan, to all access points required for the commencement cable works, based on the scope outlined in section 1.2 of this report.

2.2. Access to AP-F & AP-G (Paper Mill Lane)

Paper Mill Lane is accessed off the roundabout at junction 52 of the A14 Trunk Road. Access points AP-F & AP-G are around 530m south of the A14, along Paper Mill Lane.

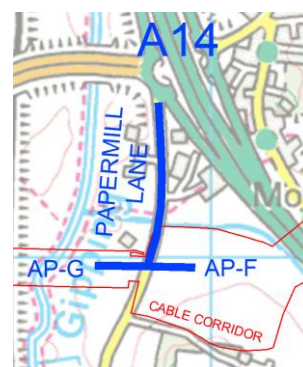

The width of carriageway on Paper Mill Lane is suitable for the majority of vehicles to pass each other safely, however there are also several passing places to assist with the passing of larger vehicles. No physical obstructions were noted during the survey which would prevent construction vehicles from reaching the access points.

Advance warning signage should be erected to warn/advise other road users of the presence of construction vehicles for the duration of the works.

Paper Mill Lane is currently subject to the National Speed Limit (60mph). Vehicle speed through the works area will therefore require to be reduced to 30mph, with the appropriate signage installed, and an application made to Suffolk County Council for a TTRO (Temporary Traffic Regulation Order).

No weight restrictions have been identified for this access route.

Table 2: Access to AP-F & AP-G Route Summary:

Question	Answer	Comments
Is access route suitable in width	YES	Route is supplemented with existing passing places
Any obstruction to prevent access	NO	No physical obstructions observed.
Are there any weight restrictions	NO	No weight restrictions identified.
Is advance warning signage required	YES	Install as per Drg No. 146103/1000
Is 30mph Speed restriction required	YES	Install as per Drg No. 146103/1000

2.3. Access to AP-W & AP-X

Access Point AP-W is located on Holly Lane. Access Point AP-X is located on an unnamed road near Playford Mount.

The access route to both AP-W & AP-X commences at the northern side of Grundisburgh, at the junction of Woodbridge Road and the B1079. All construction vehicles will proceed west along Woodbridge Road, which merges into The Street, then Rose Hill, then Ipswich Road towards Culpho Hall.

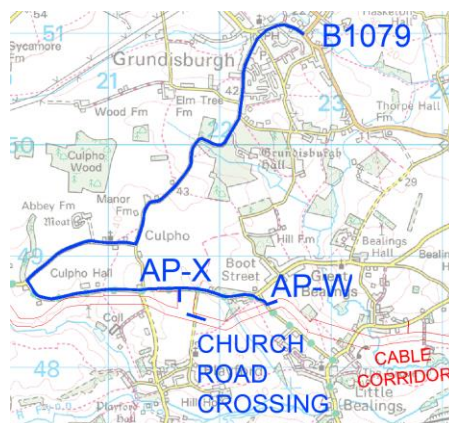

Access Point AP-X, which is located on the southern side of an unnamed road, is the first to be approached by construction vehicles using this route. Access Point AP-W will be reached by continuing east along the unnamed road to the first junction with Holly Lane. Holly lane has two junctions however the east most junction is not suitable for access and the western junction must be used. From the junction into Holly Lane, AP-W is around 170m further on and located to the east side of Holly Lane.

The route from the B1079 south to AP-X was used during the construction of the cable corridor as part of the EA1 project, with AP-X being referred to formerly as AX-08. Ten passing places were installed along this route as part of the EA1 project, and these have remained in place at the request of Suffolk County Council. Continuing on along the unnamed road towards Holly Lane and AP-W, the carriageway width would appear to be suitable for two way traffic. There are also several informal passing places which will assist during any construction traffic movements. However, given the rural nature of these roads, it is recommended that all abnormal load movements, including transport of the cable drum, are accompanied by a pilot/escort vehicle.

Ten locations along the route from the B1079 to AP-W have been identified where overhanging tree branches will impact on the transportation of the cable drum based on the use of a low-loader carrying a cable drum measuring 4.478m dia. Each location has been annotated on drawing number 146103/1010 (appendix 1), and scheduled Table 3 below:

Table 3: Grundisburgh Tree Survey

Tree Ref	Clear height to branches	Easting	Northing
GR-001	5.048m	622164.643	250217.530
GR-002	5.105m	622121.115	250136.692
GR-003	4.642m	621905.161	250032.894
GR-004	4.874m	621559.932	249559.654
GR-005	5.207m	621303.907	249278.577
GR-006	5.472m	621287.003	249223.463
GR-007	4.996m	620840.762	249114.734

GR-008	5.400m	621971.671	248633.448
GR-009	4.693m	622399.644	248568.431
GR-010	4.537m	622412.504	248547.329

The contractor should liaise with Suffolk County Council regarding trimming works to the tree locations noted above, and if required, obtain the necessary permissions to remove all branches which will impact on the cable drum transportation.

Advance warning signage should be erected to warn/advise other road users of the presence of construction vehicles for the duration of the works. Reference should be made to drawing numbers 146103/1001 and 146103/1003 (Appendix 1) associated with AP-X and AP-W.

The existing roads along the frontage of both AP-W and AP-X are currently subject to the National Speed Limit. Vehicle speed through the works area will therefore require to be reduced to 30mph, with the appropriate signage installed, and an application made to Suffolk County Council for a TTRO (Temporary Traffic Regulation Order). Speed restriction signage is indication on drawing numbers 146103/1001 and 146103/1003 (Appendix 1) associated with AP-X and AP-W.

No weight restrictions have been identified for this access route.

Table 4: Access to AP-W & AP-X Route Summary:

Question	Answer	Comments
Is access route suitable in width	YES	Route is supplemented with existing passing places
Any obstruction to prevent access	YES	Tree canopies will require trimming.
Are there any weight restrictions	NO	No weight restrictions identified.
Is advance warning signage required	YES	Install as per Drg No. 146103/1001 & 146103/1003
Is 30mph Speed restriction required	YES	Install as per Drg No. 146103/1001 & 146103/1003

2.4. Access to AP-H & AP-I

Access Points AP-H and AP-I are located on Newbourne Road. Access Point AP-H was used during the EA1 construction works, and has been partially reinstated and is now to be fully reinstated. AP-I is a new AFccess Point.

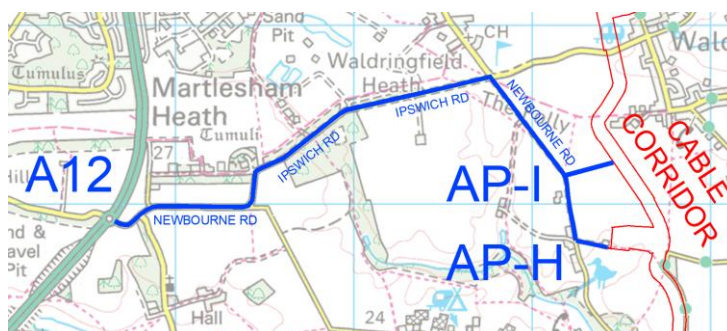

The access route to both AP-H & AP-I will commence at the A12 Roundabout, with construction traffic heading east along Newbourne Road for approximately 760m at which point the road sweeps left into Ipswich Road. Construction traffic will continue along Ipswich Road for approximately 1.7km taking the next junction with Newbourne Road, to the south. Travelling along Newbourne Road, AP-I is located approximately

690m to the south on the left hand side, with AP-H being a further 400m south, on the left hand side.

The route from the A12 east along Newbourne Road to AP-H was used for the construction of the cable corridor as part of the EA1 project, with AP-H formerly being referred to as AX-14. The first section of the route from the A12 roundabout, to the junction of Ipswich Road and Newbourne Road (1.46km) is suitable in width for two vehicles passing each other. There are also several informal passing places which will assist during any construction traffic movements. From the junction of Ipswich Road and Newbourne Road, the route south towards AP-H & AP-I was upgraded to provide passing places as part of the EA1 project and these have remained in place. Forward visibility is good throughout this access route. However, given the rural nature of these roads, it is recommended that all abnormal load movements, including transport of the cable drum, are accompanied by a pilot/escort vehicle.

Eleven locations along the route from the A12 Roundabout to AP-H have been identified where overhanging tree branches will impact on the transportation of the cable drum based on the use of a low-loader carrying a cable drum measuring 4.478m dia. Each location has been annotated on Drg No. 146103/1009 (appendix 1), and scheduled in Table 5 below:

Table 5: Newbourne Tree Survey

Tree Ref	Clear height to branches	Easting	Northing
NR-001	5.030m	624995.904	243961.979
NR-002	5.090m	625008.917	243961.959
NR-003	5.125m	625873.272	244440.355
NR-004	5.119m	625939.255	244495.424
NR-005	5.429m	626034.063	244523.986
NR-006	5.311m	626089.759	244537.138
NR-007	5.253m	626117.577	244543.562
NR-008	4.926m	626152.238	244551.566
NR-009	4.835m	626198.780	244562.264
NR-010	5.103m	626223.212	244567.772
NR-011	4.777m	626410.008	244610.381

The contractor should liaise with Suffolk County Council regarding trimming works to the tree locations noted above, and if required, obtain the necessary permissions to remove all branches which will impact on the cable drum transportation.

Advance warning signs should be erected to warn all road users of the presence of construction vehicles during the works. Reference should be made to drawing numbers 146103/1004 and 146103/1005 (Appendix 1) associated with AP-I and AP-H.

The existing roads along the frontage of both AP-H and AP-I are currently subject to the National Speed Limit. Vehicle speed through the works area will therefore require to be reduced to 30mph, with the appropriate signage installed, and an application made to Suffolk County Council for a TTRO (Temporary Traffic Regulation Order).

Speed restriction signage is indicated on drawing numbers 146103/1004 and 146103/1005 (Appendix 1) associated with AP-I and AP-H.

No weight restrictions have been identified for this access route.

Table 6: Access to AP-H & AP-I Route Summary:

Question	Answer	Comments
Is access route suitable in width	YES	Route is supplemented with existing passing places
Any obstruction to prevent access	YES	Tree canopies will require trimming.
Are there any weight restrictions	NO	No weight restrictions identified.
Is advance warning signage required	YES	Install as per Drg No. 146103/1004 & 146103/1005
Is 30mph Speed restriction required	YES	Install as per Drg No. 146103/1004 & 146103/1005

2.5. Overall Route Summary

Based on the findings of the route assessment, the only works which will be required in order to accommodate the abnormal load movement (Cable Drum), are trimming of tree canopies as noted in Tables 3 and 5.

The passing places which were constructed during the installation of the cable corridor associated with EA1 have been retained at the request of Suffolk County Council, and these will assist with the abnormal load movement in a similar way to EA1.

The use of a pilot/escort vehicle for all abnormal load movements is recommended.

3.0 Access Junction Design & Public Road Crossings

3.1. General Description

Six Access Junctions and Two public road crossings have been assessed as part of this investigation and are indicated on Figure 1, Section 1.1.

Each junction provides access from the local road network into the cable corridor for the required commencement works. In addition, two locations where the proposed cable corridor haul road crosses the public highway have been assessed. All based on the scope outlined in section 1.2 of this report.

3.2. AP-F & AP-G

Access Points AP-F and AP-G, were previously used for the construction of the cable corridor associated with the EA1 project. AP-F was previously designated as AX-05 with AP-G being designated as AX-04.

AX-04 (AP-G) was fully removed on completion of the EA1 project, with all verges and field reinstated.

AX-05 (AP-F) was partially removed. The filter/deceleration lane was removed and the junction radii reconfigured to tie in with the channel of Paper Mill Lane.

Both AX-04 and AX-05 (AP-g and AP-F) were previously approved by Suffolk County Council and also underwent a Stage 1/2 Road Safety Audit, along with a Stage 3 Road Safety Audit.

Due to the successful operation of the previously approved junctions, the proposal for this phase of works associated with EA3 is to simply reinstate each junction to the exact specification of those previously approved.

Refer to drawing number 146103/1000 for details (Appendix1).

3.3. AP-X

Access Point AP-X, was previously used for the construction of the cable corridor associated with the EA1 project. AP-X was previously designated as AX-08.

AX-08 (AP-X) was fully removed on completion of the EA1 project, with all verges and field reinstated.

AX-08 (AP-X) was previously approved by Suffolk County Council and also underwent a Stage 1/2 Road Safety Audit, along with a Stage 3 Road Safety Audit.

Due to the successful operation of the previously approved junction, the proposal for this phase of works associated with EA3 is to simply reinstate the junction to the exact specification of that previously approved.

Refer to drawing number 146103/1001 for details (Appendix1).

3.4. AP-W

AP-W is a proposed new access point, located to the east side of Holly Lane, and will provide access to cable corridor.

All new access junctions must take cognisance of the following design parameters:

- Junction radii designed to suit the requirements of an articulated low-loader.
- Allowance for sufficient length of hardstanding surface off the adjoining carriageway in order to prevent vehicles from blocking the public highway
- Designed with suitable junction visibility to suit the speed of the main road
- Junction to be within the width of the confines of the cable corridor.
- An access gate to be located across the end of the junction which opens in towards the cable corridor.

Vehicle swept path analysis has been undertaken to prove that an articulated low-loader HGV can access each junction, without the need to over-run and verges.

The extent of hard surfacing to the junction has been set back 20.0m from the eastern channel line of Holly Lane. This will allow the articulated low-loader, which is 17.918m in length, to sit fully off the public highway when the haul road access gates are closed, and not impact any other road users on Holly Lane.

Holly lane is currently subject to the National Speed Limit. However, Suffolk County Council has previously advised that all public roads, in the vicinity of any access points, should be reduced to 30mph. Accordingly, junction visibility splays should be set with an X-distance of 2.4m and a Y-distance of 90m, which would comply with the requirements of DMRB CD123 & CD109. However, if the compliant visibility splay is to be implemented, this would result in the loss of three mature trees as shown opposite. An alternative proposal has therefore been designed to minimise the loss of trees.



A system of temporary STOP/GO boards will be implemented for all vehicles exiting access AP-W. These will be installed and operated in strict accordance with the requirements of "The Traffic Signs Manual, Chapter 8, Part 1, Section D5.8" The use of the STOP/GO system will allow the minimal traffic on Holly Lane to be held at a suitable location on the public road whilst vehicles exit AP-W in a safe controlled manner. The STOP/GO system will be in addition to the advance warning signage. A Method Statement for the implementation and operation of the proposed STOP/GO system is included in Appendix 2.

Refer to drawing number 146103/1003 for details of AP-W (Appendix1).

3.5. AP-H

Access Point AP-H, was previously used for the construction of the cable corridor associated with the EA1 project. AP-H was previously designated as AX-14.

AX-14 (AP-H) was partially removed, with the access into Clapitts retained. The remainder of AX-14 was removed on completion of the EA1 project, with all verges and field reinstated with a Type 1 sub-base finish.

AX-14 (AP-H) was previously approved by Suffolk County Council and also underwent a Stage 1/2 Road Safety Audit, along with a Stage 3 Road Safety Audit.

Due to the successful operation of the previously approved junction, the proposal for this phase of works associated with EA3 is to install a new junction in exactly the same location as the previous EA1 access, albeit to a slightly reduced size to comply with the different Order Limits pertaining to EA3.

Refer to drawing number 146103/1005 for details (Appendix1).

3.6. AP-I

AP-I is a proposed new access point, located to the east side of Newbourne Road, which will provide access to the cable corridor. The location of AP-I replaces one of the passing places (HX-08-PP-05), which was constructed as part of the EA1 project.

All new access junctions must take cognisance of the following:

- Junction radii designed to suit the requirements of an articulated low-loader.
- Allowance for sufficient length of hardstanding surface off the adjoining carriageway in order to prevent vehicles from blocking the public highway
- Designed with suitable junction visibility to suit the speed of the main road
- Junction to be within the width of the confines of the cable corridor.
- An access gate to be located across the end of the junction which opens in towards the cable corridor.

In order to accommodate the turning manoeuvre into the junction, the junction radii have been set at 10.0m. This allows the articulated low-loader vehicle to turn into the junction without over-running any verges on Newbourne Road.

The extent of hard surfacing to the junction has been set back 20.0m from the eastern channel line of Holly Lane. This will allow the articulated low-loader, which is 17.918m in length, to sit fully off the public highway when the haul road access gates are closed, and not impact any other road users on Newbourne Road.

Newbourne is currently subject to the National Speed Limit. However, Suffolk County Council has previously advised that all public roads, in the vicinity of any access points, should be reduced to 30mph. Accordingly, junction visibility splays have been set with an X-distance of 2.4m and a Y-distance of 90m, which complies with the requirements of DMRB CD123 & CD109. The proposed junction fully complies with the visibility splay requirements with no vegetation clearance required.

Refer to drawing number 146103/1004 for details of AP-I (Appendix1).

3.7.

3.8. CR1 & 2

CR1 & CR2 will be used for continuity of the Haul Road where it crosses the public highway (The Street, Newbourne). Only construction traffic requiring to cross the road will be permitted to use the crossings. No construction traffic will be permitted to enter the crossing point via the public highway.

The crossing points each side of the public highway will consist of a 6.5m wide asphalt finished surface, which will extend a minimum of 20.0m beyond the channel line of the public highway.

Gates will be provided at the 20m set back, which will be manned at all times when construction traffic is using the crossing.

The safe working procedures for using public road crossing should be as follows:

- Open access gate on side of approach from haul road.
- Drive through access gate onto asphalt surfacing and stop before public road.
- Gate staff will operate stop/go boards on the public road when safe to do so.
- Vehicle will proceed across public road upon gate staff instructions.
- Vehicle to stop within asphalt surface on opposite side and ensure vehicle is fully off the public road.
- Access gates opened and proceed onto next section of haul road.
- All gates are to be securely closed to prevent public access.

Due to the operational procedures noted above, visibility splays are not considered to be relevant, however as an added safety measure, these have been included in the designs, with the requirements for vegetation clearance within the visibility splay noted.

Fairhurst has obtained the As-Built survey file for the previously design public road crossings installed by Roadbridge, on behalf of SPR, during the course of the EA1 project. The proposed arrangement has therefore been based on the crossing being established in the exact same location to that previously used for the EA1 works.

Refer to drawing number 146103/1006 for details of AP-I (Appendix1).

3.9. Haul Road Crossing at Church Road

The crossing of Church Road will be used to provide continuity of the Haul Road, and will only be used for the crossing of construction traffic. No construction traffic will be permitted to enter the crossing point via the public highway.

The crossing points each side of the public highway will consist of a 6.5m wide asphalt finished surface, which will extend a minimum of 20.0m beyond the channel line of the public highway.

Gates will be provided at the 20m set back, which will be manned at all times when construction traffic is using the crossing.

The safe working procedures for using public road crossing will be as per 3.7.

Due to the operational procedures noted above, visibility splays are not considered to be relevant, however as an added safety measure, these have been included in the designs, with the requirements for vegetation clearance within the visibility splay noted.

Fairhurst has obtained the As-Built survey file for the previously design public road crossings installed by Roadbridge, on behalf of SPR, during the course of the EA1 project. The proposed arrangement has therefore been based on the crossing being established in the exact same location to that previously used for the EA1 works.

Refer to drawing number 146103/1002 for details of the Church Road Crossing (Appendix1).

4.0 Existing Services

4.1. Electrical and Telecom Services

During the site survey works, overhead electrical cables and telecom cables, which cross the public highway, were observed in numerous locations. No survey information was obtained as to the height of each service cable, as this would have required specialist non-contact measuring devices.

Published guidance notes indicate that overhead power lines should be at a minimum clearance from the ground of 5.8 metres where they cross public roads. Telecom Cables can vary in height from 4m to 7m.



The potential for existing overhead services to clash with any abnormal load movement along the public roads will require to be assessed and confirmed using specialist non-contact survey equipment, with all works taking full cognisance of the requirements of GSE Guidance Note GS6 (Fourth Edition).

Woodbridge Road **Grundisburgh**



APPENDIX 1

DRAWINGS:

Drawing No.	Title:
146103-1000	ACCESS POINT AP=F & AP-G JUNCTION LAYOUT AND LOCATION PLAN
146103-1001	ACCESS POINT AP-X JUNCTION LAYOUT AND LOCATION PLAN
146103-1002	PUBLIC ROAD CROSSING, CHURCH ROAD, LOCATION PLAN AND DETAILS
146103-1003	ACCESS POINT AP-W JUNCTION LAYOUT AND LOCATION PLAN
146103-1004	ACCESS POINT AP-I JUNCTION LAYOUT AND LOCATION PLAN
146103-1005	ACCESS POINT AP-H JUNCTION LAYOUT AND LOCATION PLAN
146103-1006	PUBLIC ROAD CROSSING, CR1 & CR2, THE STREET, LOCATION PLAN AND DETAILS
146103-1007	ROAD CONSTRUCTION DETAILS
146103-1008	ROAD SIGNAGE
146103-1009	NEWBOURNE ROAD ACCESS ROUTE TO AP-H AND AP-I
146103-1010	GRUNDISBURGH ROAD ACCESS ROUTE TO AP-X AND AP-W
146103-1011	A14 TO PAPER MILL LANE ROAD ACCESS ROUTE TO AP-F AND AP-G
146103-1012	ACCESS POINT AP-AF AND AP-AG SWEPT PATH
146103-1013	ACCESS POINT AP-X SWEPT PATH
146103-1014	ACCESS POINT AP-W SWEPT PATH
146103-1015	ACCESS POINT AP-I SWEPT PATH
146103-1016	ACCESS POINT AP-H SWEPT PATH

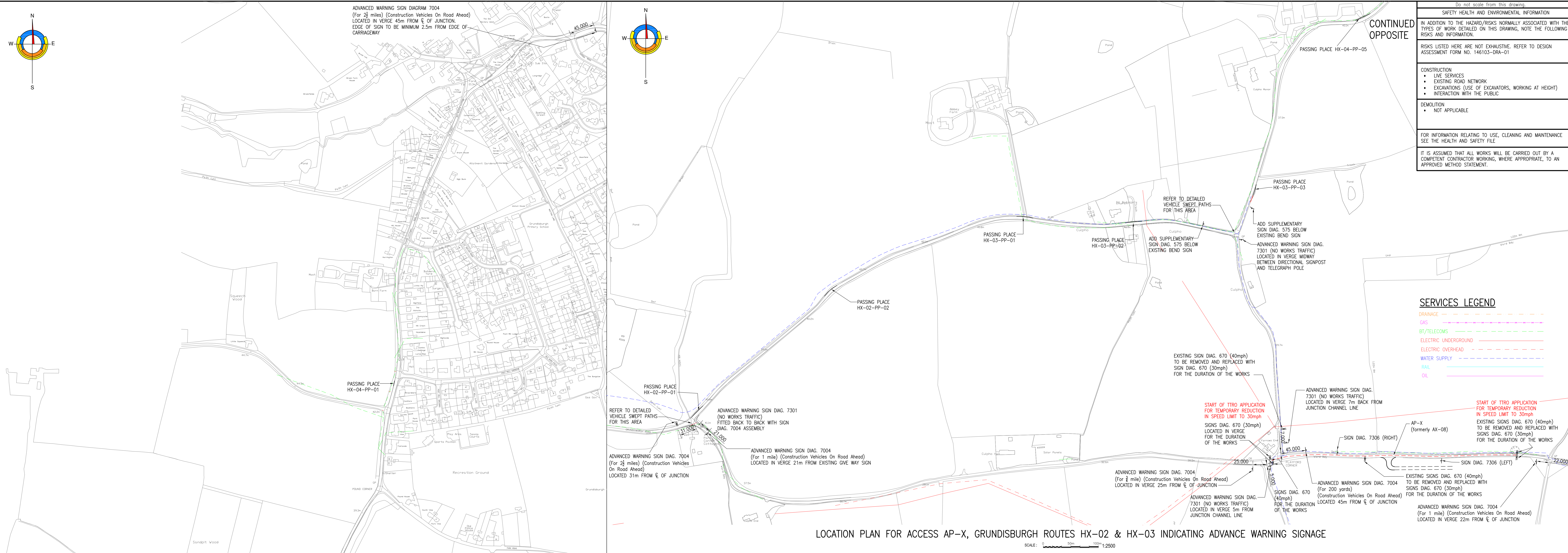

Do not scale from this drawing.

SAFETY HEALTH AND ENVIRONMENTAL INFORMATION

IN ADDITION TO THE HAZARD/RISKS NORMALLY ASSOCIATED WITH THE TYPES OF WORK DETAILED ON THIS DRAWING, NOTE THE FOLLOWING RISKS AND INFORMATION:

RISKS LISTED HERE ARE NOT EXHAUSTIVE. REFER TO DESIGN ASSESSMENT FORM NO. 146103-01A-01

CONSTRUCTION

- LIVE SERVICES
- EXISTING ROAD NETWORK
- EXCAVATIONS (USE OF EXCAVATORS, WORKING AT HEIGHT)
- INTERACTION WITH THE PUBLIC

DEMOLITION

- NOT APPLICABLE

FOR INFORMATION RELATING TO USE, CLEANING AND MAINTENANCE SEE THE HEALTH AND SAFETY FILE

IT IS ASSUMED THAT ALL WORKS WILL BE CARRIED OUT BY AN COMPETENT CONTRACTOR WORKING, WHERE APPROPRIATE, TO AN APPROVED METHOD STATEMENT

SERVICES LEGEND

- DRAINAGE
- GAS
- BT/TELECOMS
- ELECTRIC UNDERGROUND
- ELECTRIC OVERHEAD
- WATER SUPPLY
- RAIL
- OIL

LOCATION PLAN FOR ACCESS AP-X, GRUNDISBURGH ROUTES HX-02 & HX-03 INDICATING ADVANCE WARNING SIGNAGE

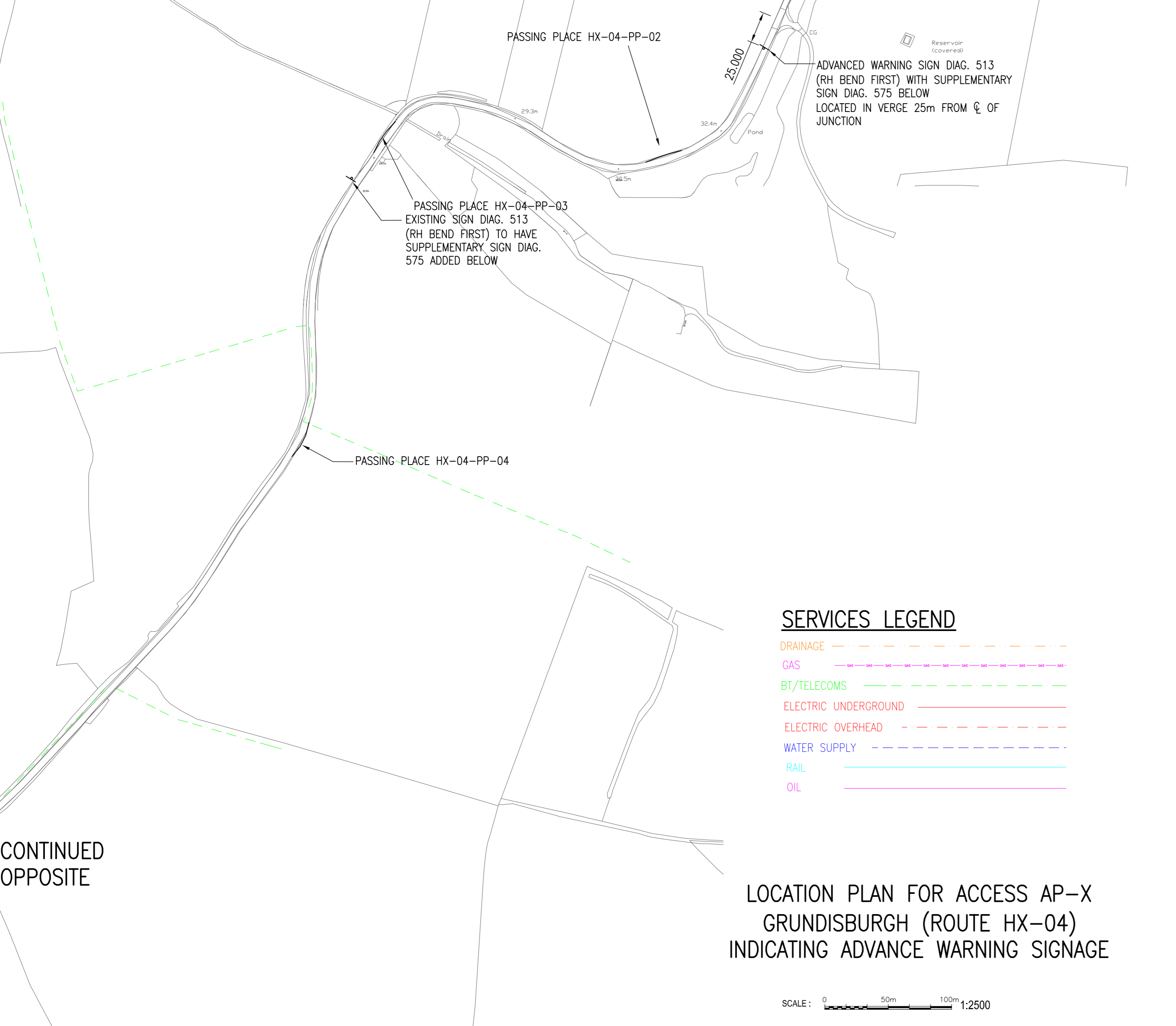

LOCATION PLAN FOR ACCESS AP-X GRUNDISBURGH (ROUTE HX-04) INDICATING ADVANCE WARNING SIGNAGE

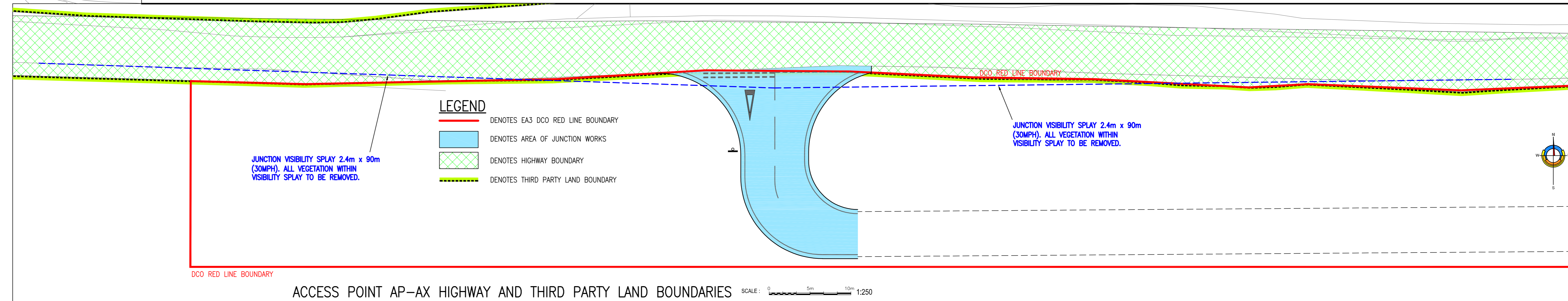

ACCESS POINT AP-AX HIGHWAY AND THIRD PARTY LAND BOUNDARIES

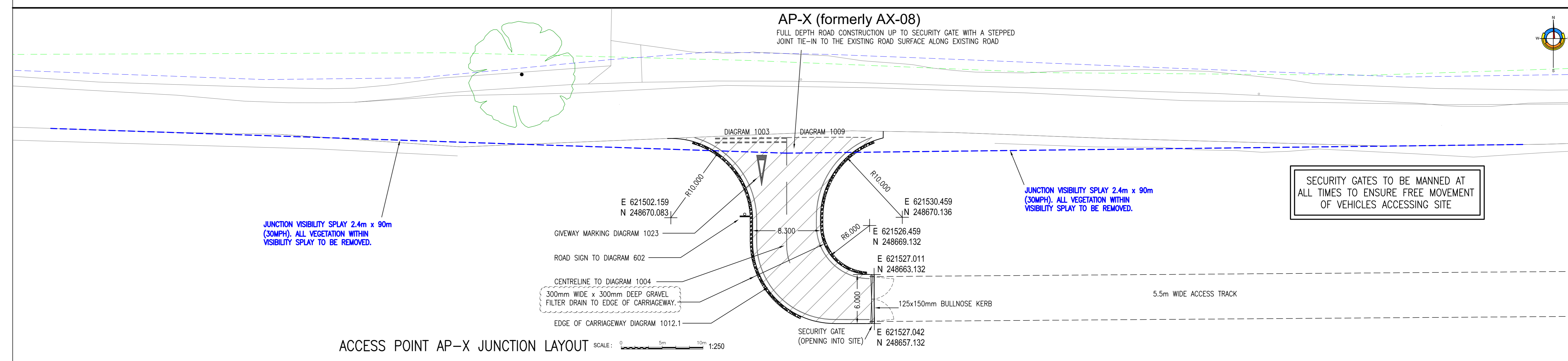

ACCESS POINT AP-X JUNCTION LAYOUT

Rev.	Date	Description	Drawn	Checked	Approved
F	15.04.22	EXTENTS OF VISIBILITY SPLAYS NOW SHOWN. NOTES REGARDING NEW FILTER DRAINS ADDED. ALL SHOWN CLOUDED.	ACM	GAV	GAV
E	06.04.22	FILTER STRIP ADDED TO OUTER EDGE OF JUNCTION.	SC	GAV	GAV
D	24.03.22	GENERAL UPDATE FOLLOWING COMMENTS FROM CLIENT AND SOC.	ACM	GAV	GAV
C	18.03.22	UPDATED TO SHOW NKT ACCESS TRACK ALIGNMENT SWEEP PATHS REMOVED. REFER TO DRG 146103/1013 FOR DETAILS	ACM	GAV	GAV
B	11.03.22	JUNCTION VISIBILITY SPLAYS UPDATED TO BE 2.4m x 90m HIGHWAY AND THIRD PARTY LAND BOUNDARY PLAN ADDED.	ACM	GAV	GAV
A	20.12.21	DCO RED BOUNDARY LINE ADDED TO JUNCTION LAYOUT DETAIL.	ACM	GAV	GAV

- Notes:
- THIS DRAWING IS TO BE READ IN CONJUNCTION WITH ALL RELEVANT DRAWINGS AND SPECIFICATIONS.
 - ALL WORKS ARE TO BE CARRIED OUT IN ACCORDANCE WITH THE SPECIFICATION FOR HIGHWAY WORKS.
 - FOR ROAD CONSTRUCTION DETAILS AND NOTES, REFER TO DRAWING NO. 146103/1007.
 - FOR ROAD SIGNAGE DETAILS AND NOTES REFER TO DRAWING NO. 146103/1008.
 - PROPOSED SIGN LOCATIONS SHOWN ARE INDICATIVE ONLY. FINAL POSITIONS TO BE ESTABLISHED ON SITE IN CONJUNCTION WITH SUFFOLK COUNTY COUNCIL.
 - REGULAR SIGNAGE INSPECTIONS AND MAINTENANCE TO BE CARRIED OUT, FOR THE DURATION OF THE WORKS, TO AVOID POSSIBLE OBSTRUCTION BY SEASONAL VEGETATION GROWTH.
 - FOR SWEEP PATH ANALYSIS PLEASE REFER TO DRAWING 146103/1013

Project Title: **EA3 HVDC ROUTE PRE-COMMENCEMENT WORKS TRANSPORT ASSESSMENT**

Client: **NKT**

Contractor: **SCOTTISHPOWER RENEWABLES**

Project No: **146103/1001**

Revision: **F**

Issue No: **1**

Issue Date: **12/11/21**

Issue By: **ACM**

Issue For: **FOR APPROVAL**

Issue To: **FOR APPROVAL**

Issue Date: **11/11/21**

Issue By: **GAV**

Issue For: **FOR APPROVAL**

Issue To: **FOR APPROVAL**

Issue Date: **11/11/21**

Issue By: **GAV**

Issue For: **FOR APPROVAL**

Issue To: **FOR APPROVAL**

FAIRHURST

Southampton Road, SUNDLEY, OSA 79N
Tel: 01382 853300 Fax: 0844 281 4412

Issue No: **1**

Issue Date: **12/11/21**

Issue By: **ACM**

Issue For: **FOR APPROVAL**

Issue To: **FOR APPROVAL**

Issue Date: **11/11/21**

Issue By: **GAV**

Issue For: **FOR APPROVAL**

Issue To: **FOR APPROVAL**

Issue Date: **11/11/21**

Issue By: **GAV**

Issue For: **FOR APPROVAL**

Issue To: **FOR APPROVAL**

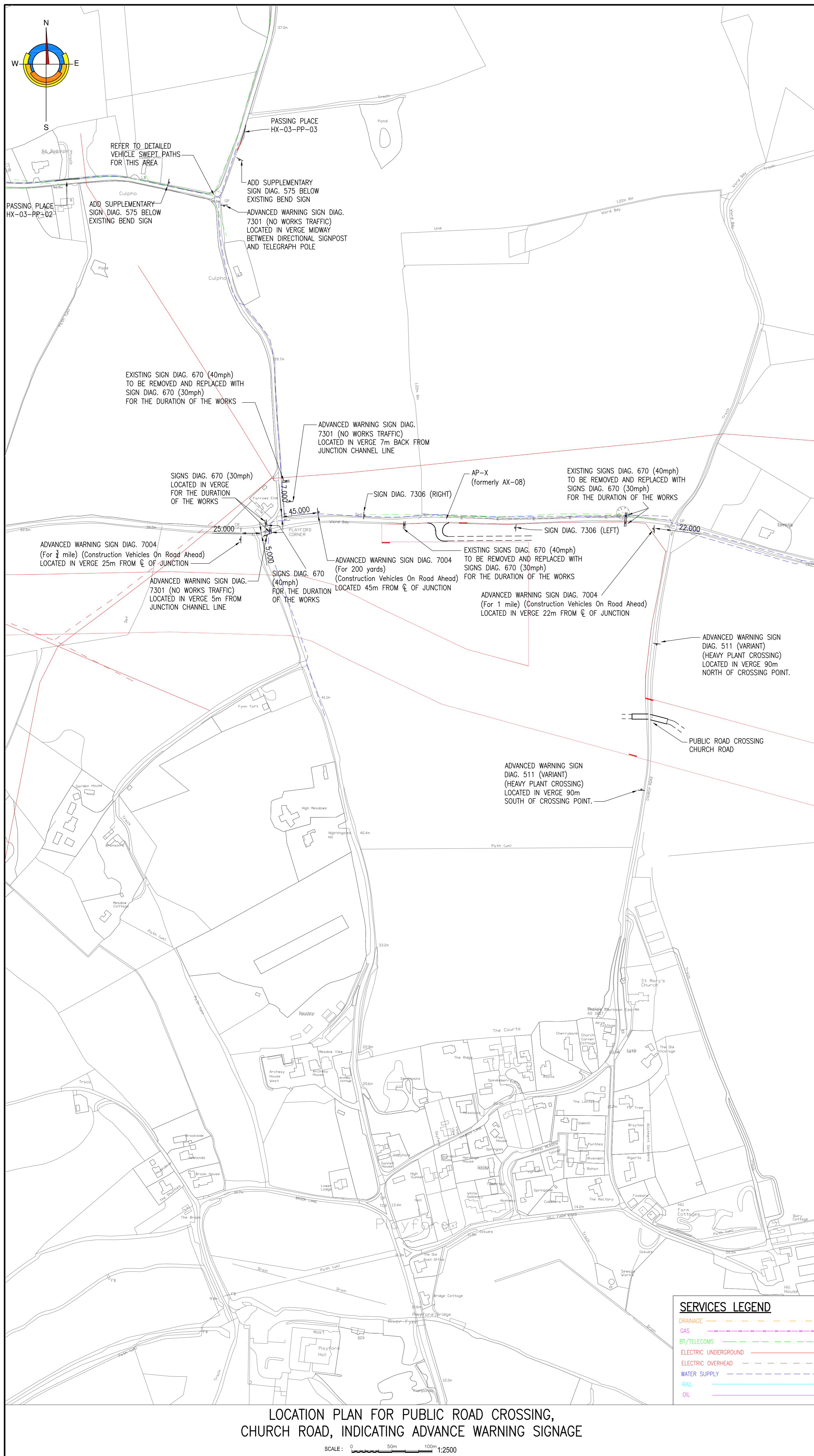

LOCATION PLAN FOR PUBLIC ROAD CROSSING, CHURCH ROAD, INDICATING ADVANCE WARNING SIGNAGE

SCALE: 0 10m 20m 1:2500

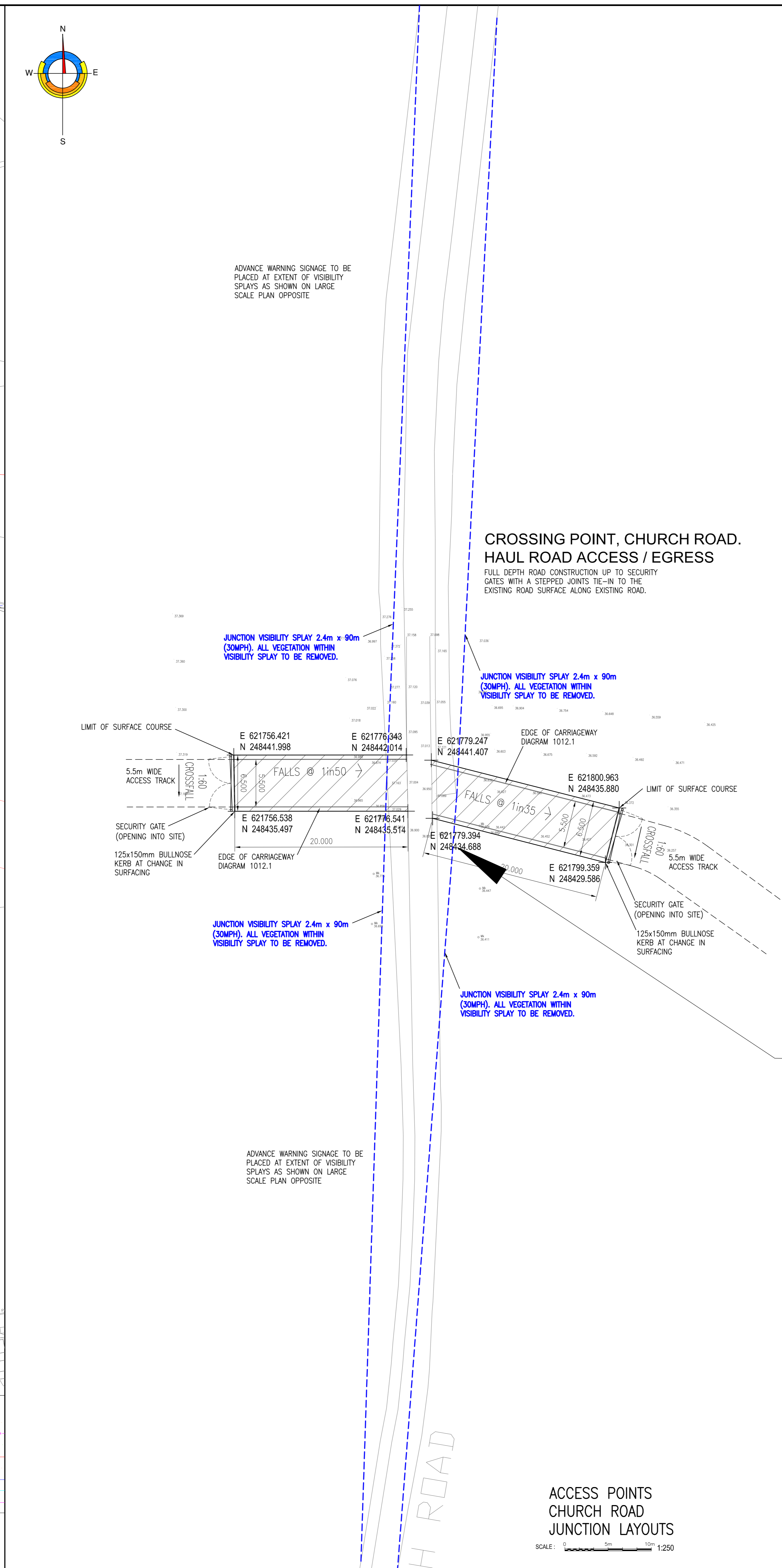

CROSSING POINT, CHURCH ROAD. HAUL ROAD ACCESS / EGRESS

ACCESS POINTS CHURCH ROAD JUNCTION LAYOUTS

SCALE: 0 5m 10m 1:250

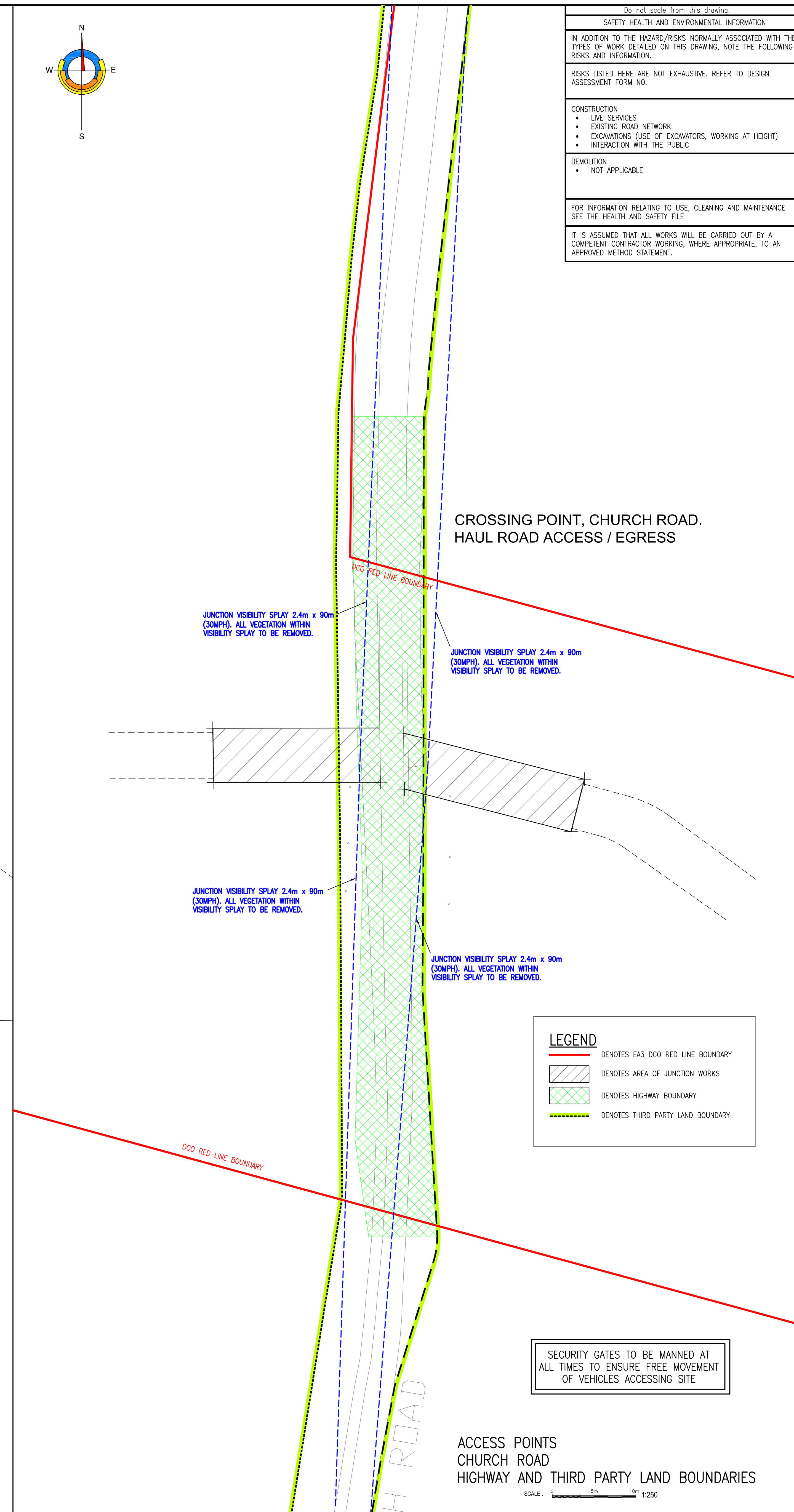

CROSSING POINT, CHURCH ROAD. HAUL ROAD ACCESS / EGRESS

ACCESS POINTS CHURCH ROAD HIGHWAY AND THIRD PARTY LAND BOUNDARIES

SCALE: 0 5m 10m 1:250

Do not scale from this drawing.

SAFETY HEALTH AND ENVIRONMENTAL INFORMATION

IN ADDITION TO THE HAZARD/RISKS NORMALLY ASSOCIATED WITH THE TYPES OF WORK DETAILED ON THIS DRAWING, NOTE THE FOLLOWING RISKS AND INFORMATION.

RISKS LISTED HERE ARE NOT EXHAUSTIVE. REFER TO DESIGN ASSESSMENT FORM NO.

CONSTRUCTION

- LIVE SERVICES
- EXISTING ROAD NETWORK
- EXCAVATIONS (USE OF EXCAVATORS, WORKING AT HEIGHT)
- INTERACTION WITH THE PUBLIC

DEMOLITION

- NOT APPLICABLE

FOR INFORMATION RELATING TO USE, CLEANING AND MAINTENANCE SEE THE HEALTH AND SAFETY FILE

IT IS ASSUMED THAT ALL WORKS WILL BE CARRIED OUT BY A COMPETENT CONTRACTOR WORKING, WHERE APPROPRIATE, TO AN APPROVED METHOD STATEMENT

LEGEND

- Denotes EA3 DCO RED LINE BOUNDARY
- Denotes AREA OF JUNCTION WORKS
- Denotes HIGHWAY BOUNDARY
- Denotes THIRD PARTY LAND BOUNDARY

SECURITY GATES TO BE MANNED AT ALL TIMES TO ENSURE FREE MOVEMENT OF VEHICLES ACCESSING SITE

Rev.	Date	Description	Drawn	Checked	Approved
D	25.04.22	UPDATED TO SHOW FULL EXTENTS OF VISIBILITY SPLAYS.	ACM	GAV	GAV
C	18.03.22	UPDATED TO SHOW NKT ACCESS TRACK ALIGNMENT	ACM	GAV	GAV
B	11.03.22	JUNCTION VISIBILITY SPLAYS ADDED (2.4m x 90m)	ACM	GAV	GAV
A	20.12.21	DCO RED BOUNDARY LINE ADDED TO JUNCTION LAYOUT DETAIL.	ACM	GAV	GAV

- Notes:
- THIS DRAWING IS TO BE READ IN CONJUNCTION WITH ALL RELEVANT DRAWINGS AND SPECIFICATIONS.
 - ALL WORKS ARE TO BE CARRIED OUT IN ACCORDANCE WITH 'THE SPECIFICATION FOR HIGHWAY WORKS'.
 - FOR ROAD CONSTRUCTION DETAILS AND NOTES, REFER TO DRAWING No. 146103/1007.
 - FOR ROAD SIGNAGE DETAILS AND NOTES REFER TO DRAWING No. 146103/1008.
 - PROPOSED SIGN LOCATIONS SHOWN ARE INDICATIVE ONLY. FINAL POSITIONS TO BE ESTABLISHED ON SITE IN CONJUNCTION WITH SUFFOLK COUNTY COUNCIL.
 - REGULAR SIGNAGE INSPECTIONS AND MAINTENANCE TO BE CARRIED OUT, FOR THE DURATION OF THE WORKS, TO AVOID POSSIBLE OBSTRUCTION BY SEASONAL VEGETATION GROWTH.

Client: **NKT**

Project Title: **EA3 HVDC ROUTE PRE-COMMENCEMENT WORKS TRANSPORT ASSESSMENT**

Drawing Title: **PUBLIC ROAD CROSSING CHURCH ROAD JUNCTION LAYOUTS AND LOCATION PLAN**

Issue: **AS SHOWN** FOR APPROVAL

Issue Date: 17/03/2022

Issue Time: 17/03/2022

Issue By: [Signature]

Issue For: [Signature]

Issue No: **146103/1002**

Issue Date: 17/03/2022

Issue Time: 17/03/2022

Issue By: [Signature]

Issue For: [Signature]

Issue No: **D**

FAIRHURST

Southampton Road, SUNDLEY, Essex SS4 7RN
Tel: 01862 853300 Fax: 0844 281 4412

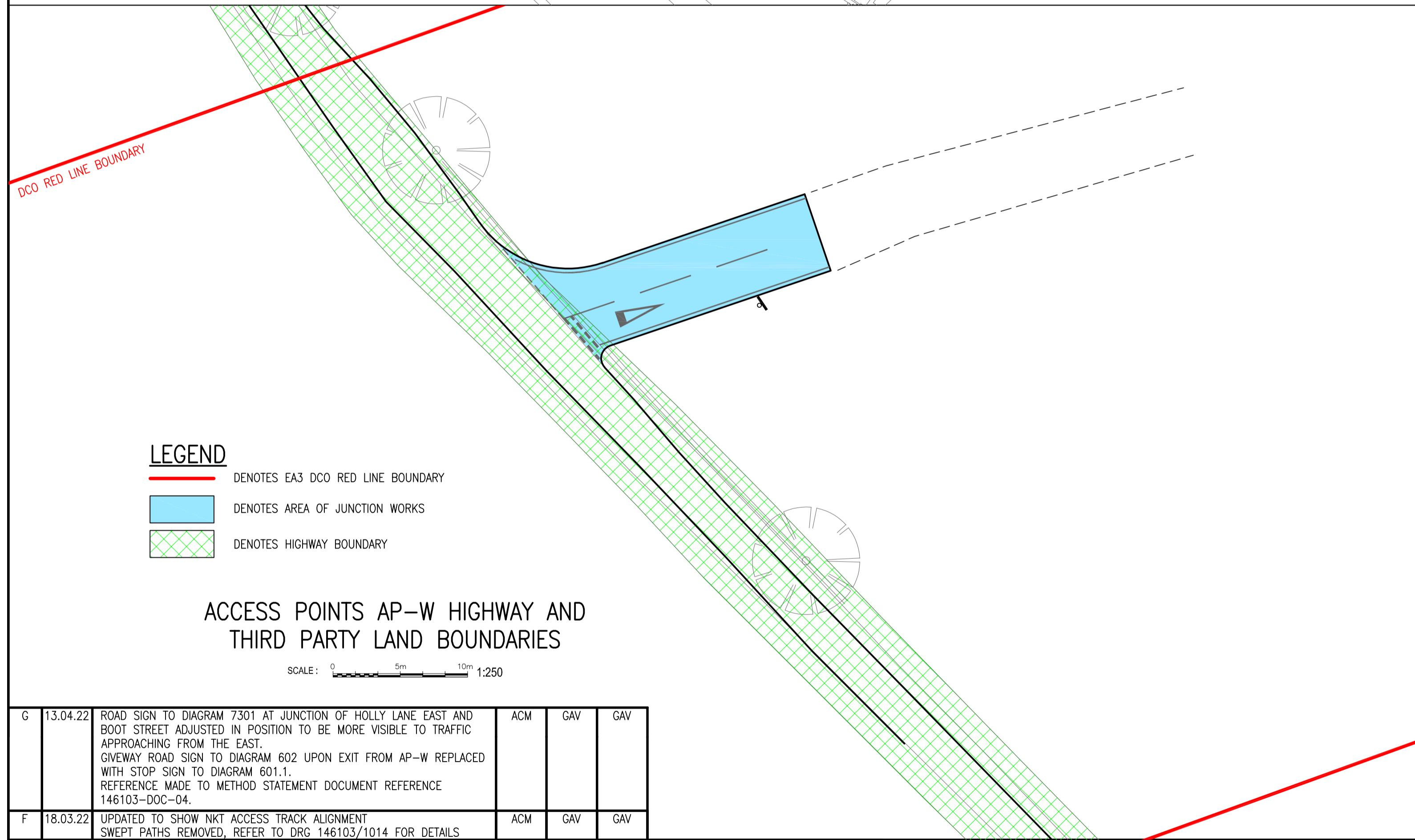
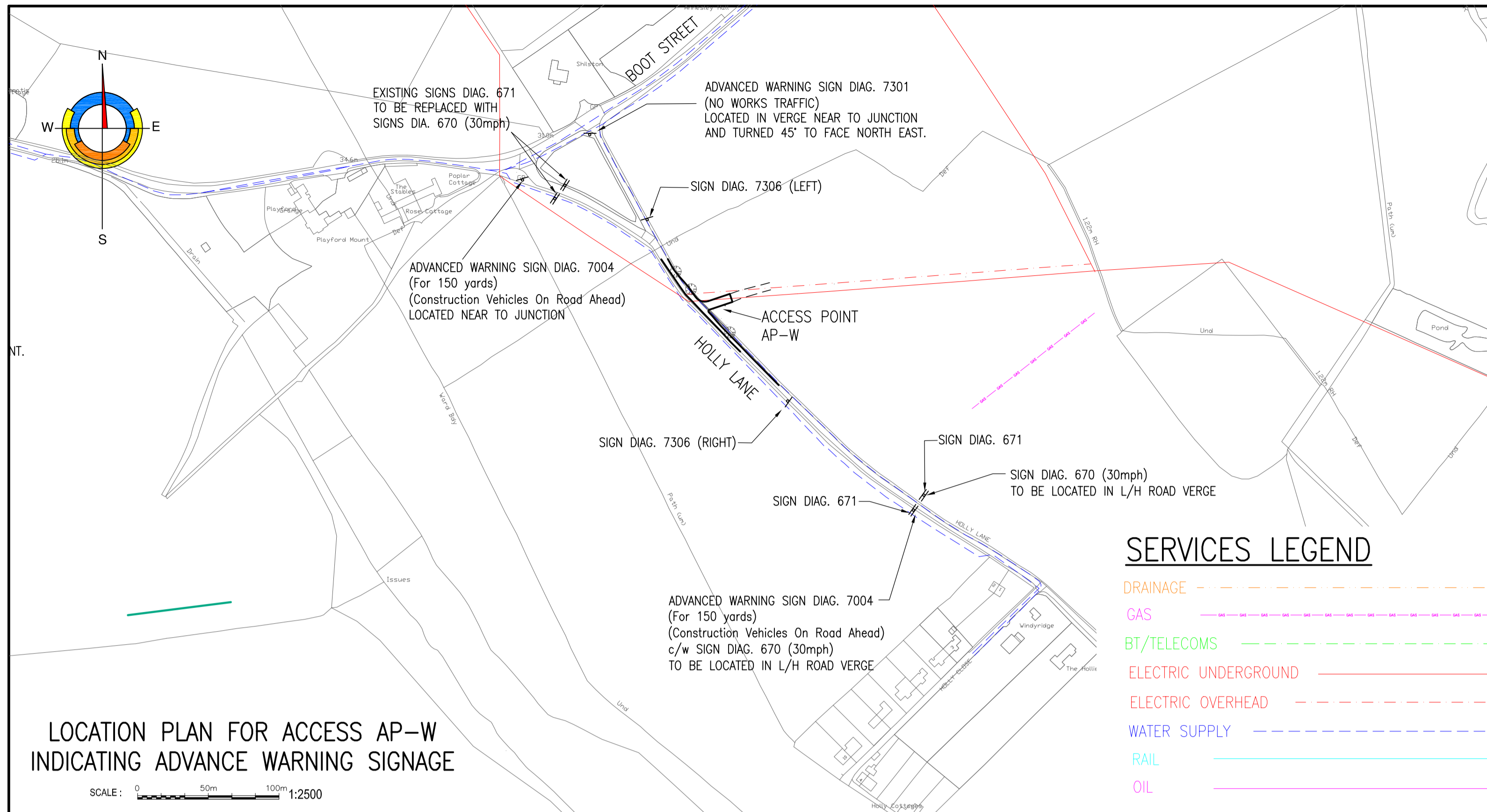

Rev.	Date	Description	Drawn	Checked	Approved
G	13.04.22	ROAD SIGN TO DIAGRAM 7301 AT JUNCTION OF HOLLY LANE EAST AND BOOT STREET ADJUSTED IN POSITION TO BE MORE VISIBLE TO TRAFFIC APPROACHING FROM THE EAST. GIVEWAY ROAD SIGN TO DIAGRAM 602 UPON EXIT FROM AP-W REPLACED WITH STOP SIGN TO DIAGRAM 601.1. REFERENCE MADE TO METHOD STATEMENT DOCUMENT REFERENCE 146103-DOC-04.	ACM	GAV	GAV
F	18.03.22	UPDATED TO SHOW NKT ACCESS TRACK ALIGNMENT SWEEP PATHS REMOVED, REFER TO DRG 146103/1014 FOR DETAILS	ACM	GAV	GAV
E	11.03.22	JUNCTION VISIBILITY SPLAYS ADDED (2.4m x 90m) HIGHWAY BOUNDARY INFORMATION ADDED	ACM	GAV	GAV
D	06.01.22	JUNCTION ARRANGEMENT UPDATED TO MINIMISE IMPACT OF EXISTING TREE IMMEDIATELY NORTH OF JUNCTION FOLLOWING RECEIPT OF ARBORICULTURAL REPORT BY BOWLAND TREE CONSULTANCY LTD.	ACM	GAV	GAV
C	20.12.21	DCO RED BOUNDARY LINE ADDED TO JUNCTION LAYOUT DETAIL. TRAFFIC SIGN TO Dia. 7301 REMOVED FROM NO ENTRY LIMB OF NORTHBOUND CHURCH LANE AS PER SCC EMAIL DATED 13/12/2021	ACM	GAV	GAV
B	19.11.21	TO SUIT THE REQUIREMENTS TO RETAIN THE EXISTING MATURE TREES, WHICH SIGNIFICANTLY IMPACT ON THE AVAILABLE JUNCTION VISIBILITY. CHAPTER 8 COMPLIANT STOP/GO BOARDS HAVE BEEN PROPOSED AS ADDITIONAL SAFETY MEASURES.	ACM	GAV	GAV
A	12.11.21	ADDITIONAL SIGNS DIAG. 7301 ADDED TO HOLLY LANE EAST, FACING NORTHBOUND TRAFFIC. DESIGN PHILOSOPHY FOR JUNCTION UPDATED.	ACM	GAV	GAV

- Notes:
- THIS DRAWING IS TO BE READ IN CONJUNCTION WITH ALL RELEVANT DRAWINGS AND SPECIFICATIONS.
 - ALL WORKS ARE TO BE CARRIED OUT IN ACCORDANCE WITH 'THE SPECIFICATION FOR HIGHWAY WORKS'.
 - FOR ROAD CONSTRUCTION DETAILS AND NOTES, REFER TO DRAWING No. 146103/1007.
 - FOR ROAD SIGNAGE DETAILS AND NOTES REFER TO DRAWING No. 146103/1008.
 - PROPOSED SIGN LOCATIONS SHOWN ARE INDICATIVE ONLY. FINAL POSITIONS TO BE ESTABLISHED ON SITE IN CONJUNCTION WITH SUFFOLK COUNTY COUNCIL.
 - REGULAR SIGNAGE INSPECTIONS AND MAINTENANCE TO BE CARRIED OUT, FOR THE DURATION OF THE WORKS, TO AVOID POSSIBLE OBSTRUCTION BY SEASONAL VEGETATION GROWTH.
 - FOR SWEEP PATH ANALYSIS PLEASE REFER TO DRAWING 146103/1014

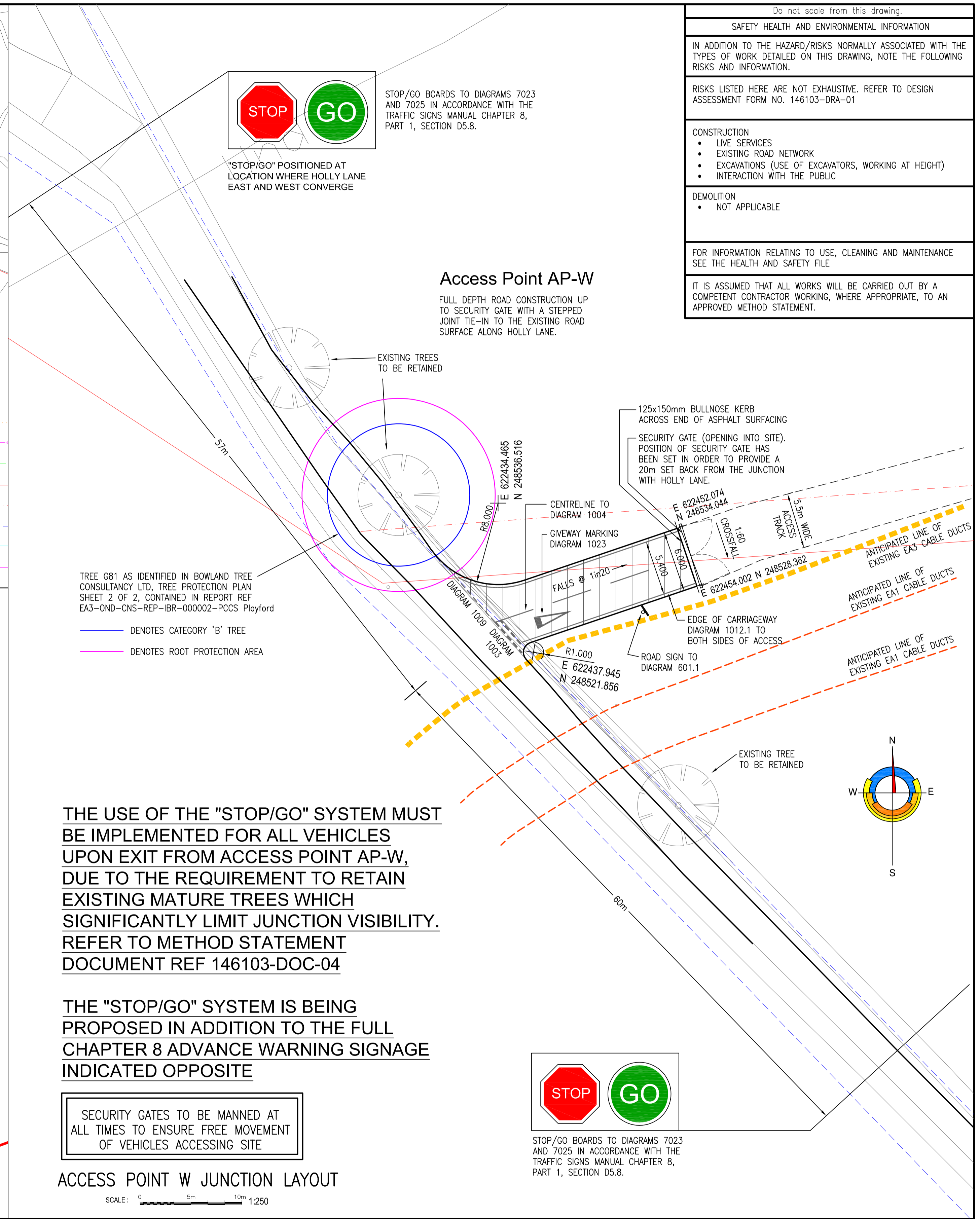

THE USE OF THE "STOP/GO" SYSTEM MUST BE IMPLEMENTED FOR ALL VEHICLES UPON EXIT FROM ACCESS POINT AP-W, DUE TO THE REQUIREMENT TO RETAIN EXISTING MATURE TREES WHICH SIGNIFICANTLY LIMIT JUNCTION VISIBILITY. REFER TO METHOD STATEMENT DOCUMENT REF 146103-DOC-04

THE "STOP/GO" SYSTEM IS BEING PROPOSED IN ADDITION TO THE FULL CHAPTER 8 ADVANCE WARNING SIGNAGE INDICATED OPPOSITE

SECURITY GATES TO BE MANNED AT ALL TIMES TO ENSURE FREE MOVEMENT OF VEHICLES ACCESSING SITE

ACCESS POINT W JUNCTION LAYOUT

Do not scale from this drawing.

SAFETY HEALTH AND ENVIRONMENTAL INFORMATION

IN ADDITION TO THE HAZARD/RISKS NORMALLY ASSOCIATED WITH THE TYPES OF WORK DETAILED ON THIS DRAWING, NOTE THE FOLLOWING RISKS AND INFORMATION:

RISKS LISTED HERE ARE NOT EXHAUSTIVE. REFER TO DESIGN ASSESSMENT FORM NO. 146103-DRA-01

CONSTRUCTION

- LIVE SERVICES
- EXISTING ROAD NETWORK
- EXCAVATIONS (USE OF EXCAVATORS, WORKING AT HEIGHT)
- INTERACTION WITH THE PUBLIC

DEMOLITION

- NOT APPLICABLE

FOR INFORMATION RELATING TO USE, CLEANING AND MAINTENANCE SEE THE HEALTH AND SAFETY FILE

IT IS ASSUMED THAT ALL WORKS WILL BE CARRIED OUT BY A COMPETENT CONTRACTOR WORKING, WHERE APPROPRIATE, TO AN APPROVED METHOD STATEMENT.

Client:

Project Title:

EA3 HVDC ROUTE PRE-COMMENCEMENT WORKS TRANSPORT ASSESSMENT

Drawing Title:

ACCESS POINT AP-W JUNCTION LAYOUT AND LOCATION PLAN

FAIRHURST

Westerton of Craigie,
Southampton Road, DUNDEE, DD4 7PN
Tel: 01382 453300 Fax: 0844 381 4412

Scale at A1: AS SHOWN

Status: FOR APPROVAL

Drawn: ACM	Checked: GAV	Approved: GAV
Date: 09/11/21	Date: 09/11/21	Date: 09/11/21

Drawing No.: 146103/1003

Revision: G

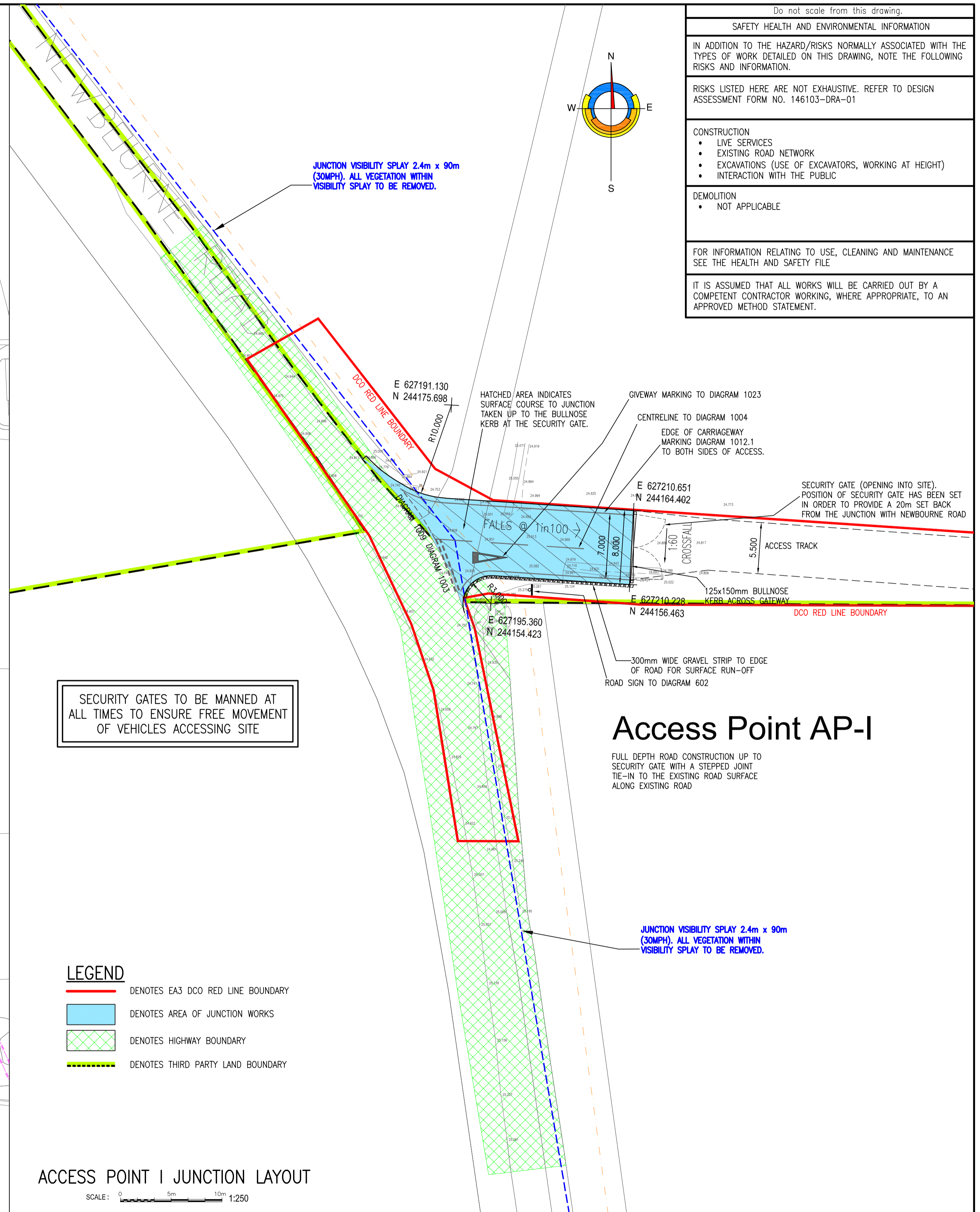
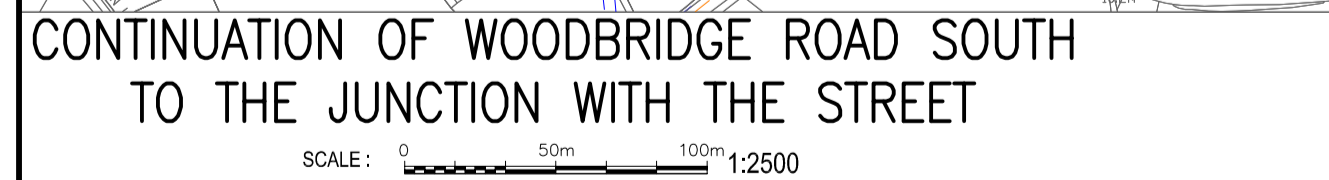
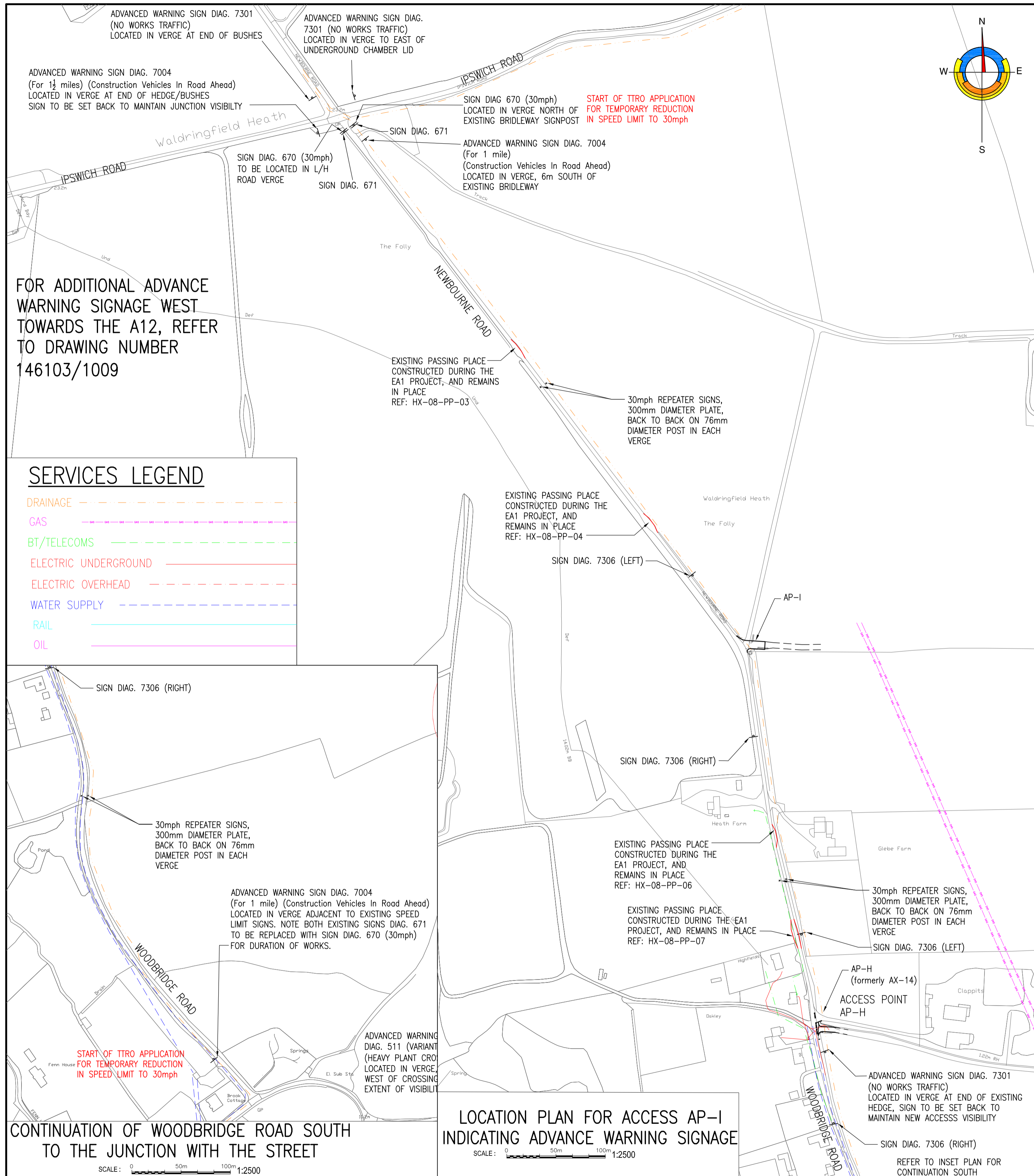

Do not scale from this drawing.

SAFETY HEALTH AND ENVIRONMENTAL INFORMATION

IN ADDITION TO THE HAZARD/RISKS NORMALLY ASSOCIATED WITH THE TYPES OF WORK DETAILED ON THIS DRAWING, NOTE THE FOLLOWING RISKS AND INFORMATION:

RISKS LISTED HERE ARE NOT EXHAUSTIVE. REFER TO DESIGN ASSESSMENT FORM NO. 146103-DRA-01

CONSTRUCTION

- LIVE SERVICES
- EXISTING ROAD NETWORK
- EXCAVATIONS (USE OF EXCAVATORS, WORKING AT HEIGHT)
- INTERACTION WITH THE PUBLIC

DEMOLITION

- NOT APPLICABLE

FOR INFORMATION RELATING TO USE, CLEANING AND MAINTENANCE SEE THE HEALTH AND SAFETY FILE

IT IS ASSUMED THAT ALL WORKS WILL BE CARRIED OUT BY A COMPETENT CONTRACTOR WORKING, WHERE APPROPRIATE, TO AN APPROVED METHOD STATEMENT.

Rev.	Date	Description	Drawn	Checked	Approved
C	18.03.22	UPDATED TO SHKW NKT ACCESS TRACK ALIGNMENT SWEEP PATHS REMOVED, REFER TO DRG 146103/1015 FOR DETAILS	ACM	GAV	GAV
B	11.03.22	JUNCTION VISIBILITY SPLAYS ADDED (2.4m x 90m) HIGHWAY BOUNDARY INFORMATION ADDED	ACM	GAV	GAV
A	20.12.21	DCO RED BOUNDARY LINE ADDED TO JUNCTION LAYOUT DETAIL. JUNCTION LAYOUT AMENDED TO REMAIN WITHIN RED LINE BOUNDARY.	ACM	GAV	GAV

Notes:

- THIS DRAWING IS TO BE READ IN CONJUNCTION WITH ALL RELEVANT DRAWINGS AND SPECIFICATIONS.
- ALL WORKS ARE TO BE CARRIED OUT IN ACCORDANCE WITH 'THE SPECIFICATION FOR HIGHWAY WORKS'.
- FOR ROAD CONSTRUCTION DETAILS AND NOTES, REFER TO DRAWING No. 146103/1007.
- FOR ROAD SIGNAGE DETAILS AND NOTES REFER TO DRAWING No. 146103/1008.
- PROPOSED SIGN LOCATIONS SHOWN ARE INDICATIVE ONLY. FINAL POSITIONS TO BE ESTABLISHED ON SITE IN CONJUNCTION WITH SUFFOLK COUNTY COUNCIL.
- REGULAR SIGNAGE INSPECTIONS AND MAINTENANCE TO BE CARRIED OUT, FOR THE DURATION OF THE WORKS, TO AVOID POSSIBLE OBSTRUCTION BY SEASONAL VEGETATION GROWTH.

Client:

Client:

Project Title:

EA3 HVDC ROUTE PRE-COMMENCEMENT WORKS TRANSPORT ASSESSMENT

Project Title:

ACCESS POINT AP-I JUNCTION LAYOUT AND LOCATION PLAN

FAIRHURST

Westerton of Craigie,
Southampton Road, DUNDEE, DD4 7PN
Tel: 01382 453300 Fax: 0844 381 4412

Scale at A1: AS SHOWN

Status: FOR APPROVAL

Drawn: ACM	Checked: GAV	Approved: GAV
Date: 09/11/21	Date: 09/11/21	Date: 09/11/21

Drawing No.: 146103/1004

Revision: C

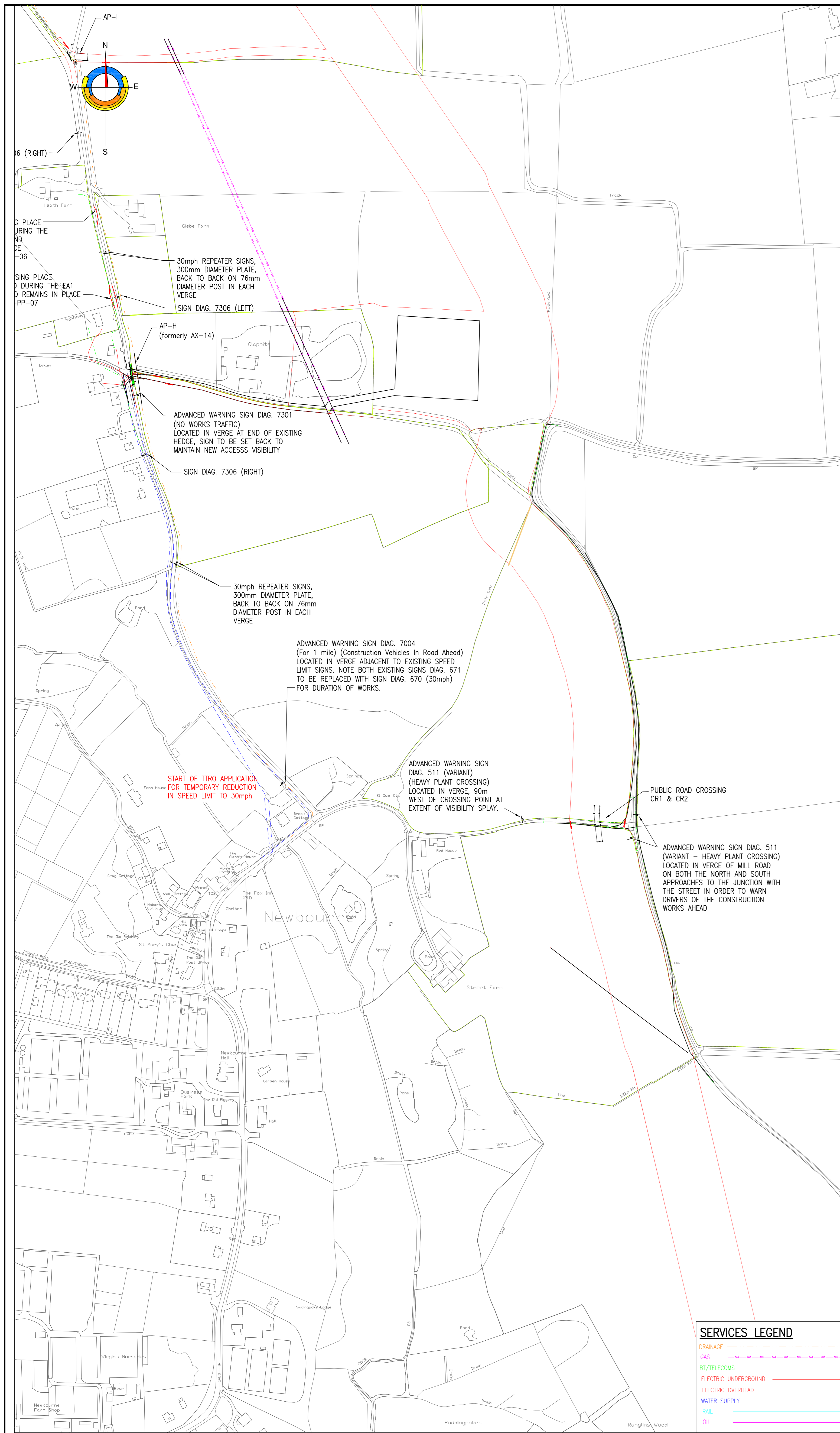

LOCATION PLAN FOR PUBLIC ROAD CROSSING, THE STREET, INDICATING ADVANCE WARNING SIGNAGE

SCALE: 1:2500

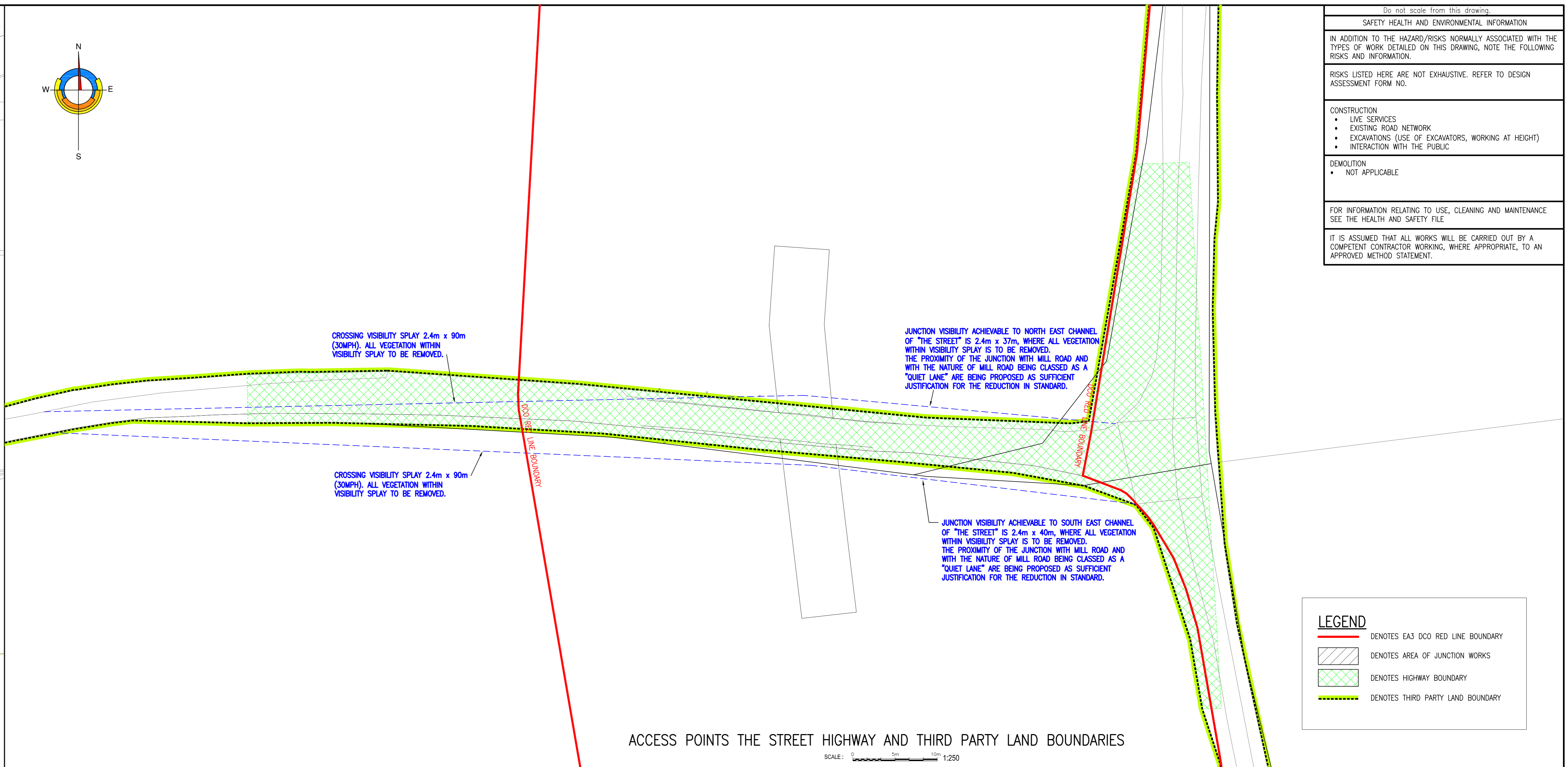

ACCESS POINTS THE STREET HIGHWAY AND THIRD PARTY LAND BOUNDARIES

SCALE: 1:2500

Do not scale from this drawing.

SAFETY HEALTH AND ENVIRONMENTAL INFORMATION

IN ADDITION TO THE HAZARD/RISKS NORMALLY ASSOCIATED WITH THE TYPES OF WORK DETAILED ON THIS DRAWING, NOTE THE FOLLOWING RISKS AND INFORMATION.

RISKS LISTED HERE ARE NOT EXHAUSTIVE. REFER TO DESIGN ASSESSMENT FORM NO.

CONSTRUCTION

- LIVE SERVICES
- EXISTING ROAD NETWORK
- EXCAVATIONS (USE OF EXCAVATORS, WORKING AT HEIGHT)
- INTERACTION WITH THE PUBLIC

DEMOLITION

- NOT APPLICABLE

FOR INFORMATION RELATING TO USE, CLEANING AND MAINTENANCE SEE THE HEALTH AND SAFETY FILE

IT IS ASSUMED THAT ALL WORKS WILL BE CARRIED OUT BY A COMPETENT CONTRACTOR WORKING, WHERE APPROPRIATE, TO AN APPROVED METHOD STATEMENT.

LEGEND

- DENOTES EAS DCO RED LINE BOUNDARY
- DENOTES AREA OF JUNCTION WORKS
- DENOTES HIGHWAY BOUNDARY
- DENOTES THIRD PARTY LAND BOUNDARY

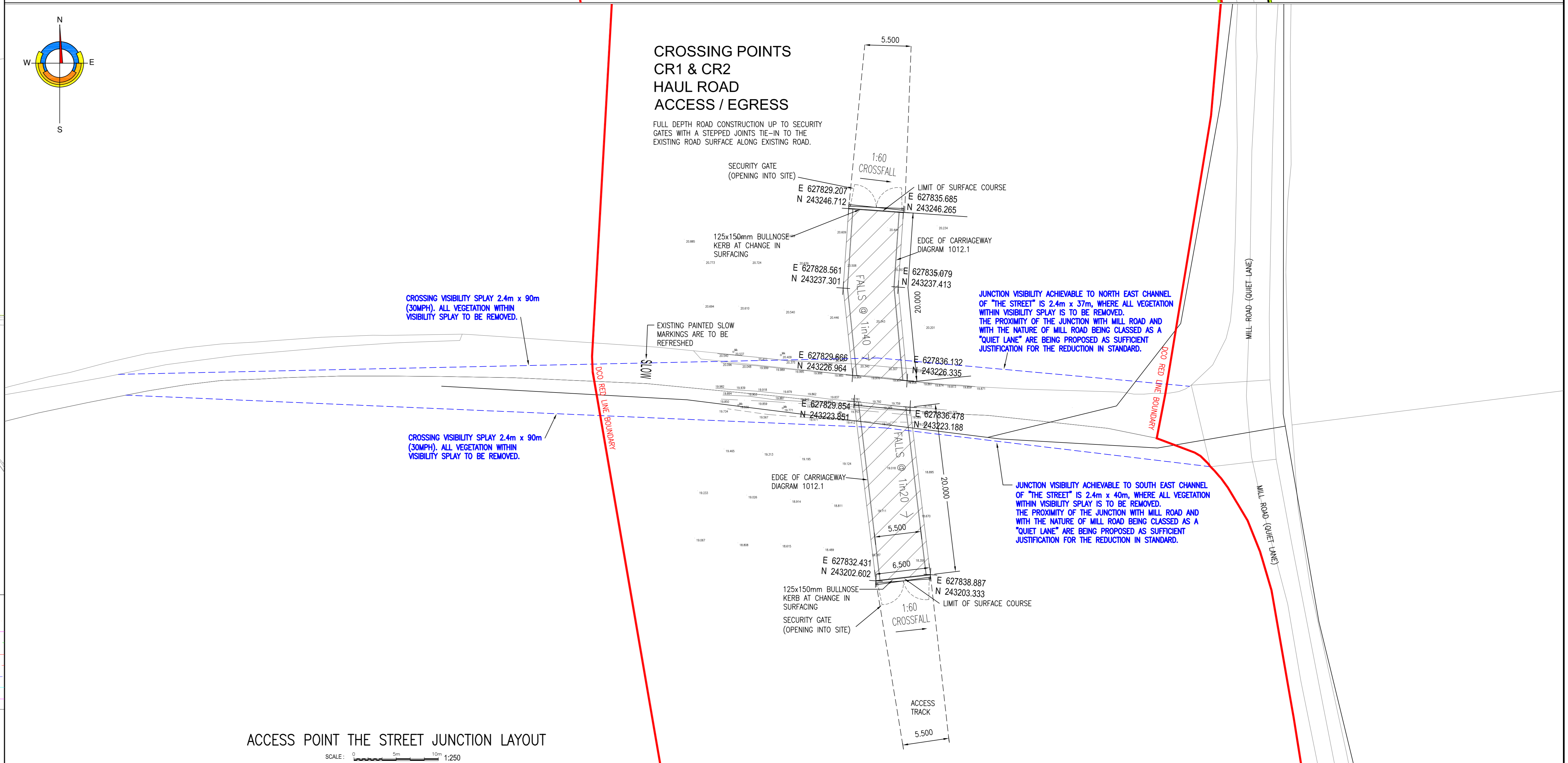

ACCESS POINT THE STREET JUNCTION LAYOUT

SCALE: 1:2500

Rev.	Date	Description	Drawn	Checked	Approved
D	25.04.22	UPDATED TO SHOW FULL EXTENT OF VISIBILITY SPAYS	ACM	GAV	GAV
C	18.03.22	UPDATED TO SHOW NKT ACCESS TRACK ALIGNMENT	ACM	GAV	GAV
B	11.03.22	VISIBILITY SPAYS ADDED TO CROSSING, ADVANCE WARNING SIGNS UPDATED	ACM	GAV	GAV
A	20.12.21	DCO RED BOUNDARY LINE ADDED TO JUNCTION LAYOUT DETAIL.	ACM	GAV	GAV

- Notes:
- THIS DRAWING IS TO BE READ IN CONJUNCTION WITH ALL RELEVANT DRAWINGS AND SPECIFICATIONS.
 - ALL WORKS ARE TO BE CARRIED OUT IN ACCORDANCE WITH 'THE SPECIFICATION FOR HIGHWAY WORKS'.
 - FOR ROAD CONSTRUCTION DETAILS AND NOTES, REFER TO DRAWING No. 146103/1007.
 - FOR ROAD SIGNAGE DETAILS AND NOTES REFER TO DRAWING No. 146103/1008.
 - PROPOSED SIGN LOCATIONS SHOWN ARE INDICATIVE ONLY. FINAL POSITIONS TO BE ESTABLISHED ON SITE IN CONJUNCTION WITH SUFFOLK COUNTY COUNCIL.
 - REGULAR SIGNAGE INSPECTIONS AND MAINTENANCE TO BE CARRIED OUT, FOR THE DURATION OF THE WORKS, TO AVOID POSSIBLE OBSTRUCTION BY SEASONAL VEGETATION GROWTH.

Project Title: **EA3 HVDC ROUTE PRE-COMMENCEMENT WORKS TRANSPORT ASSESSMENT**

Client: **FAIRHURST**

Location: **Southampton Road, SUNKLE, G24 7PW**

Phone: 01382 453300 Fax: 0844 281 4412

Scale of AS SHOWN: **FOR APPROVAL**

Drawn: **NKT**

Checked: **SCD**

Approved: **SCD**

Date: **17/03/2022**

Date: **17/03/2022**

Date: **17/03/2022**

Drawing No: **146103/1006**

Sheet: **D**

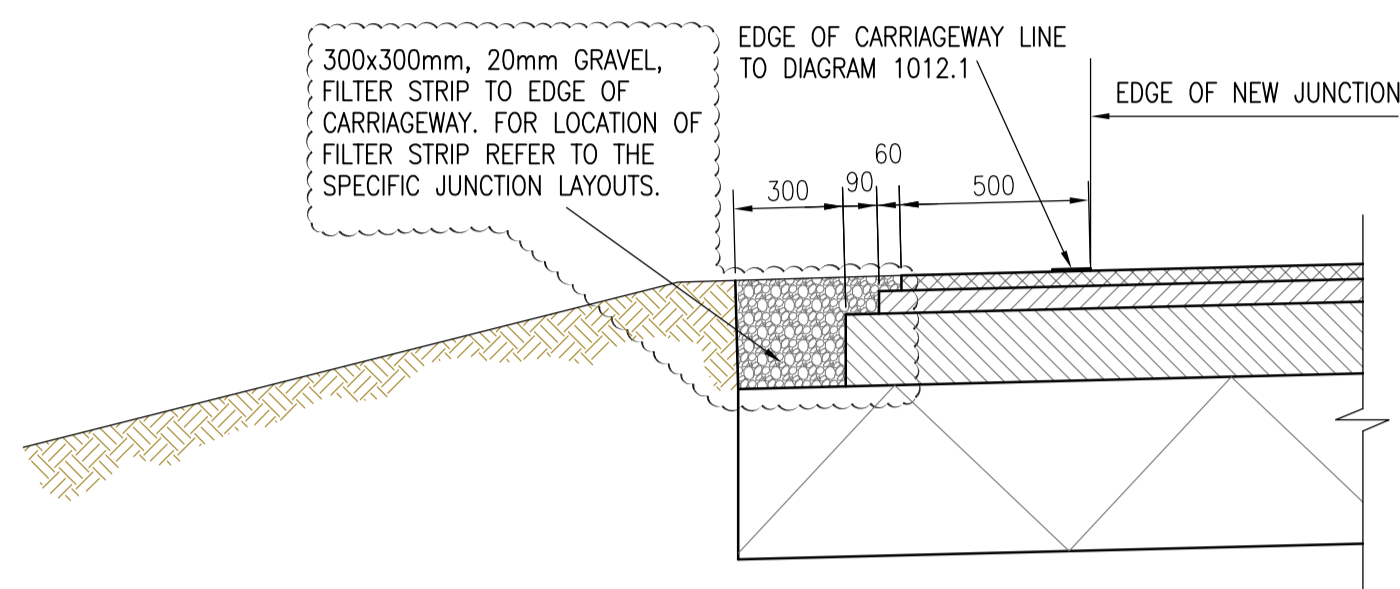

CROSS SECTION THROUGH EDGE OF NEW ACCESS CONSTRUCTION

SCALE 1:20

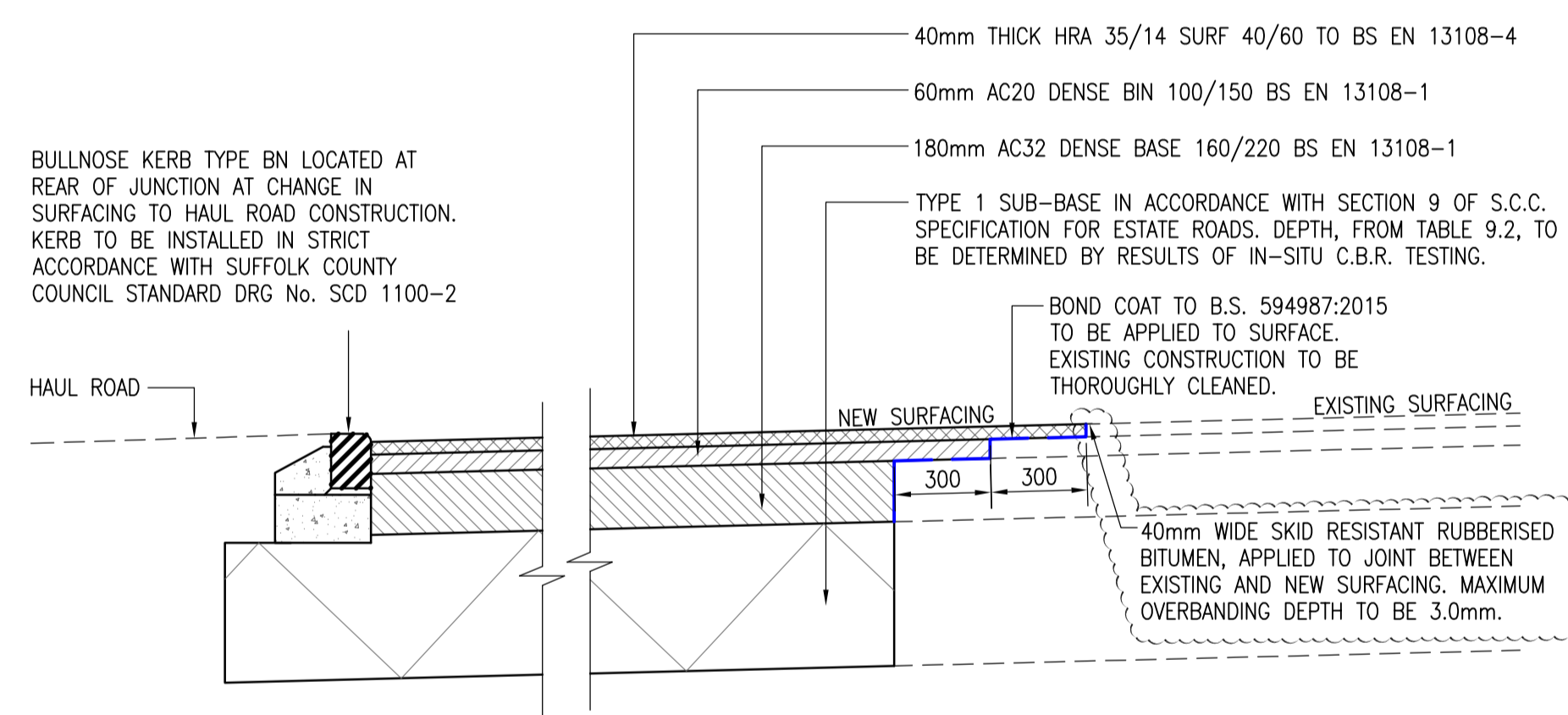

SECTION THROUGH NEW ACCESS CONSTRUCTION AT TIE-IN TO EXISTING CARRIAGEWAY

SCALE 1:20

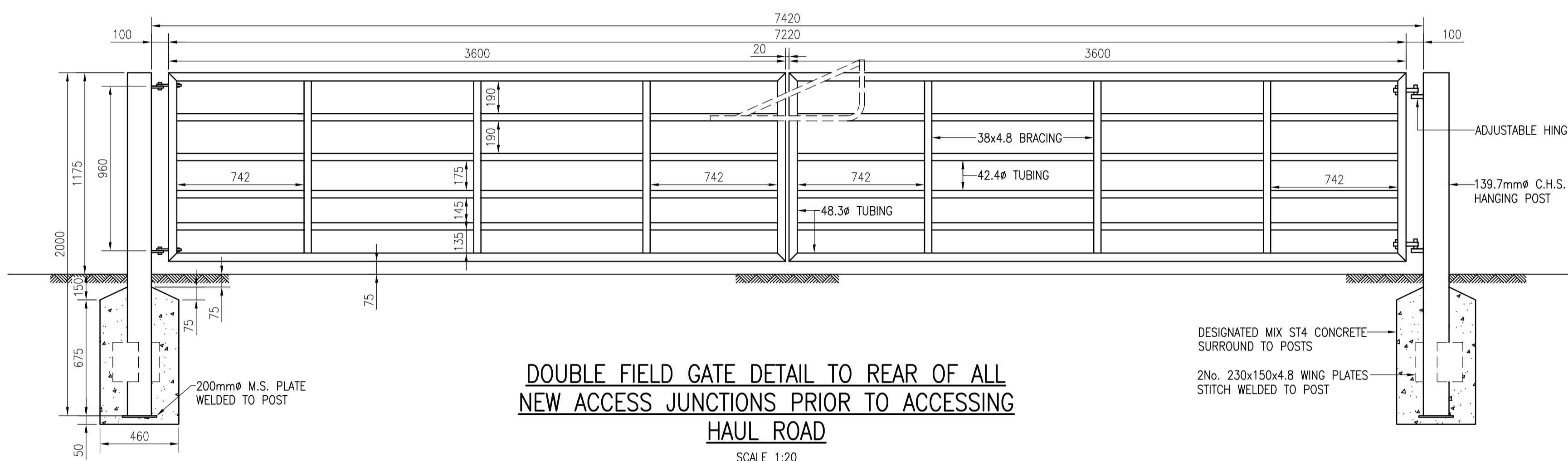



DOUBLE FIELD GATE DETAIL TO REAR OF ALL NEW ACCESS JUNCTIONS PRIOR TO ACCESSING HAUL ROAD

SCALE 1:20

- Notes:
- FOR ACCESS POINT W REFER TO DRAWING 146103/1003.
 - FOR ACCESS POINT I REFER TO DRAWING 146103/1004.

Rev.	Date	Description	Drawn	Checked	Approved
B	15.04.22	FILTER DRAIN AND JOINT SEAL DETAILS ADDED TO SECTIONS. AMENDMENTS SHOWN CLOUDED.	ACM	GAV	GLB
A	06.04.22	KERB DETAIL UPDATED.	ACM	GAV	GLB

Client:

Project Title:

**EA3 HVDC ROUTE
PRE-COMMENCEMENT WORKS
TRANSPORT ASSESSMENT**

Drawing Title:

CONSTRUCTION DETAILS

FAIRHURST

Westerton of Craigie,
Southampton Road, DUNDEE, DD4 7PN
Tel: 01382 453300 Fax: 0844 381 4412

Scale at A1:
1:20

Status:
FOR APPROVAL

Drawn:
SC

Checked:
GAV

Approved:
GAV

Date:
10/11/21

Date:
10/11/21

Date:
10/11/21

Drawing No.:
146103/1007

Revision:
B

Do not scale from this drawing.

SAFETY HEALTH AND ENVIRONMENTAL INFORMATION

IN ADDITION TO THE HAZARD/RISKS NORMALLY ASSOCIATED WITH THE TYPES OF WORK DETAILED ON THIS DRAWING, NOTE THE FOLLOWING RISKS AND INFORMATION:

RISKS LISTED HERE ARE NOT EXHAUSTIVE. REFER TO DESIGN ASSESSMENT FORM NO. 146103-DRA-01

- CONSTRUCTION :
- INTERFACE WITH THE PUBLIC
 - DEEP EXCAVATIONS
 - PRESENCE OF UNKNOWN LIVE SERVICES
 - OVERHEAD SERVICES
 - WORKING ON OR NEAR TO THE HIGHWAY

- DEMOLITION
- NOT APPLICABLE

FOR INFORMATION RELATING TO USE, CLEANING AND MAINTENANCE SEE THE HEALTH AND SAFETY FILE

IT IS ASSUMED THAT ALL WORKS WILL BE CARRIED OUT BY A COMPETENT CONTRACTOR WORKING, WHERE APPROPRIATE, TO AN APPROVED METHOD STATEMENT.

- NOTES:
1. THIS DRAWING IS TO BE READ IN CONJUNCTION WITH ALL RELEVANT DRAWINGS AND SPECIFICATIONS.
 2. FOR LOCATION OF SIGNS REFER TO THE DETAILED LAYOUT DRAWINGS SPECIFIC TO EACH ACCESS POINT AND/OR CROSSING POINT

NOTE:
FOR REQUIRED DISTANCE ANNOTATION, REFER TO THE DETAILED LAYOUT DRAWINGS SPECIFIC TO EACH ACCESS POINT AND/OR CROSSING POINT.

Oncoming vehicles in middle of road
DIAGRAM 575
SIZE : 600mm
X-HEIGHT : 62.5mm
BACKGROUND : WHITE
TEXT : BLACK
BORDER : BLACK
MATERIAL : CLASS RA2
POSTS : 76mmØ POST
BASES : 600x600x600mm
MOUNTING HEIGHT : 2250mm
LATERAL CLEARANCE : 500mm MIN

Cross
DIAGRAM 504.1
SIZE : 600mm
BACKGROUND : WHITE
BORDER : RED
MATERIAL : CLASS RA2
POSTS : 76mmØ POST
BASES : 600x600x600mm
MOUNTING HEIGHT : 2250mm
LATERAL CLEARANCE : 500mm MIN

GIVE WAY
DIAGRAM 602
SIZE : 600mm
TEXT COLOUR : BLACK
BACKGROUND : WHITE
BORDER : RED
MATERIAL : CLASS RA2
POSTS : 76mmØ POST
BASES : 600x600x600mm
MOUNTING HEIGHT : 2250mm
LATERAL CLEARANCE : 500mm MIN

STOP
DIAGRAM 601.1
SIZE : 600mm
TEXT COLOUR : WHITE
BACKGROUND : RED
BORDER : WHITE
MATERIAL : CLASS RA2
POSTS : 76mmØ POST
BASES : 600x600x600mm
MOUNTING HEIGHT : 2250mm
LATERAL CLEARANCE : 500mm MIN

No entry
DIAGRAM 671
SIZE : 600mmØ
LINE COLOUR : BLACK
BACKGROUND : WHITE
MATERIAL : CLASS RA2
POSTS : 76mmØ POST
BASES : 600x600x600mm
MOUNTING HEIGHT : 2250mm
LATERAL CLEARANCE : 500mm MIN

30
DIAGRAM 670 (30mph)
SIZE : 600mmØ
TEXT COLOUR : BLACK
BACKGROUND : WHITE
BORDER : RED
MATERIAL : CLASS RA2
POSTS : 76mmØ POST
BASES : 600x600x600mm
MOUNTING HEIGHT : 2250mm
LATERAL CLEARANCE : 500mm MIN
BACKING BOARD : YELLOW

30
DIAGRAM 670 (30mph)
(REPEATER SIGNS)
SIZE : 300mmØ
TEXT COLOUR : BLACK
BACKGROUND : WHITE
BORDER : RED
MATERIAL : CLASS RA2
POSTS : 76mmØ POST
BASES : 600x600x600mm
MOUNTING HEIGHT : 2250mm
LATERAL CLEARANCE : 500mm MIN

Construction traffic in road ahead

Signing Project	EA3	Width (mm)	1665	Background Border Legend	Yellow Black Black
Sign Reference	7004	Height (mm)	600		
x Height	75.0	Area (m²)	1.00		
Material	Class RA2				

Construction traffic in road ahead
For XX miles

Signing Project	EA3	Width (mm)	1925	Background Border Legend	Yellow Black Black
Sign Reference	7004	Height (mm)	1065		
x Height	75.0	Area (m²)	2.05		
Material	Class RA2				

Structural Calculation Details SIGN 7004

Signs:
Reference: 7004
Width: 1925mm, Height: 1065mm
Shape: Rectangle
Orientation: Facing front
Mounted on posts: 1, 2
Mounting height: 2100mm

Posts:
Quantity: 2
Type: 88.9 x 3.2 CHS
Spacing: 1425mm
Post 1 Length: 3865mm
Post 2 Length: 3865mm

Base:
Type: Combined
Width: 1900mm
Length: 1900mm
Depth: 600mm
Volume: 2.17cu.m
Earth cover: 100mm
Blinding layer: 0mm

WORKS ACCESS ONLY 100 yds
7306 (LEFT)

WORKS ACCESS ONLY 100 yds
7306 (RIGHT)

HEAVY PLANT CROSSING
SIGN REFERENCE : DIAGRAM 511 (VARIANT)

NO WORKS TRAFFIC
SIGN REFERENCE : DIAGRAM 7301 (VARIANT)

WORKS TRAFFIC
7304 (LEFT)

WORKS TRAFFIC
7304 (RIGHT)

X-HEIGHT : 62.5mm
MATERIAL : CLASS RA2
POSTS : 2x76mmØ POST
BASE : 1300x650x650mm
MOUNTING HEIGHT : 2250mm
LATERAL CLEARANCE : 500mm MIN

X-HEIGHT : 62.5mm
MATERIAL : CLASS RA2
POSTS : 1x76mmØ POST
BASE : 650x650x650mm
MOUNTING HEIGHT : 2250mm
LATERAL CLEARANCE : 500mm MIN

X-HEIGHT : 62.5mm
MATERIAL : CLASS RA2
POSTS : 1x76mmØ POST
BASE : 650x650x650mm
MOUNTING HEIGHT : 2250mm
LATERAL CLEARANCE : 500mm MIN

X-HEIGHT : 62.5mm
MATERIAL : CLASS RA2
POSTS : 1x76mmØ POST
BASE : 650x650x650mm
MOUNTING HEIGHT : 2250mm
LATERAL CLEARANCE : 500mm MIN

ALTERNATIVE FOUNDATION DETAIL FOR SIGN POST IS TO USE A LENGTH OF DRAINAGE PIPE WITH THE INTERNAL DIAMETER SUITABLE FOR THE SIGN POST DIAMETER.

1. ONCE THE VERGE HAS BEEN CLEARED FOR SERVICES USING A "CAT-SCAN", HOLE TO BE EXCAVATED TO A DEPTH OF 750mm BELOW EXISTING GROUND LEVEL. DRAINAGE PIPE TO BE INSERTED, WITH THE EXCAVATED HOLE, EXTERNAL TO THE PIPE, BACKFILLED USING RAMMED EARTH.
2. SIGNPOST TO BE INSERTED TO DRAINAGE PIPE, THEN BACKFILLED WITH GRAVEL. TIMBER WEDGES TO BE DRIVEN BETWEEN THE SIGN POST AND INSIDE OF DRAINAGE PIPE TO STABILIZE SIGN.
3. SIGN POST TO BE CHECKED AT REGULAR INTERVALS FOR THE DURATION OF THE CONTRACT.

Rev.	Date	Description	Drawn	Checked	Approved
C	13.04.22	STOP SIGN TO DIAGRAM 601.1 ADDED	ACM	GAV	GAV
B	05.04.22	30mph REPEATER SIGN DETAIL ADDED. NOTE REGARDING ALTERNATIVE FOUNDATION DETAIL ADDED.	ACM	GAV	GAV
A	12.11.21	ADDITIONAL SIGNS ADDED	ACM	GAV	GAV

	Client:		Project Title:	EA3 HVDC ROUTE PRE-COMMENCEMENT WORKS TRANSPORT ASSESSMENT	
	Project Title:		ROAD SIGNAGE		
Scale at A1: AS SHOWN			Status: FOR APPROVAL		
Drawn: SC			Checked: ACM		
Date: 10/11/21			Approved: GAV		
Date: 10/11/21			Date: 10/11/21		
Drawing No.: 146103/1008			Revision: C		

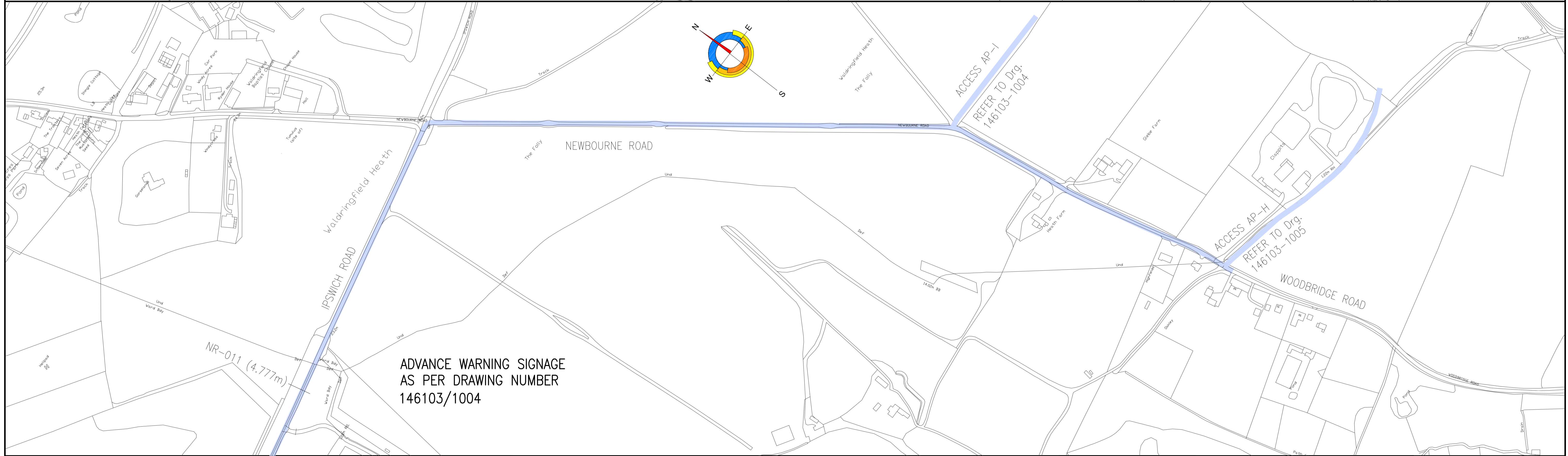
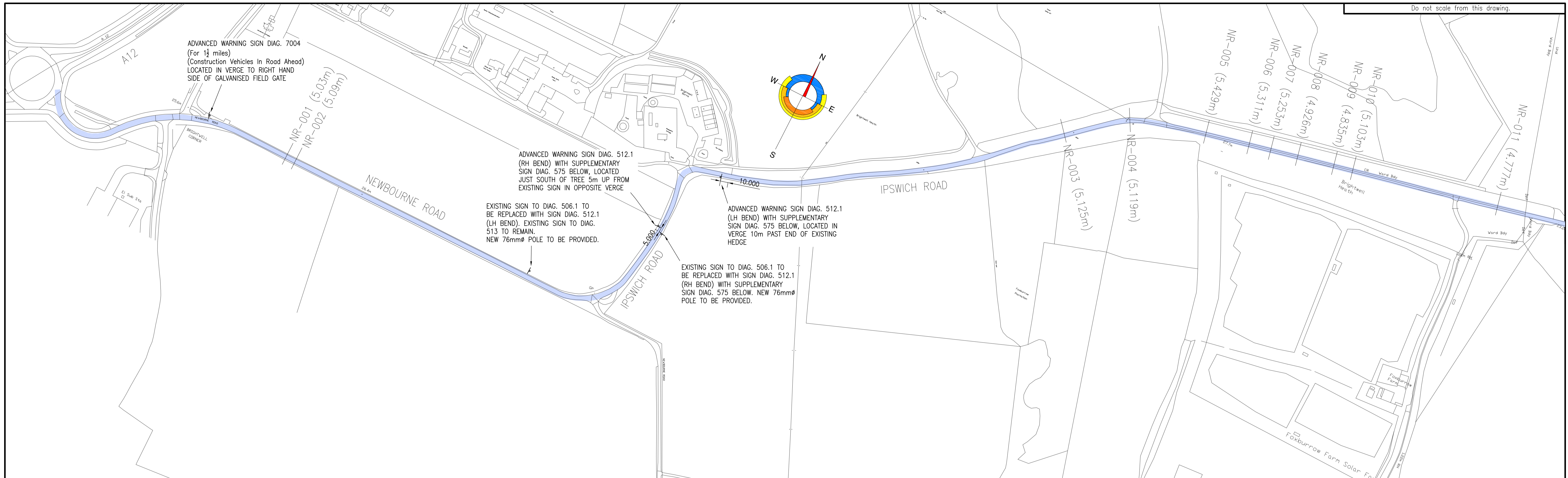

Rev.	Date	Description	Drawn	Checked	Approved
A	11.03.22	ADVANCE WARNING SIGNS ADDED TO ROUTE WHEN LEAVING THE A12	ACM	GAV	GAV

- Notes:
1. DENOTES ACCESS ROUTE FROM A12.
 2. FOR DETAILED JUNCTION ARRANGEMENTS AT AP-H AND AP-I REFER TO DRAWING 146103/1004.
 3. NR..... DENOTES TREE SURVEY LOCATION WITH SURVEYED HEIGHTS IN BRACKETS.
 4. BASED ON AN ALLOWANCE OF 5.4m HEIGHT (CABLE DRUM ON LOW-LOADER) ANY TREE BRANCHES BELOW THIS HEIGHT SHOULD BE REMOVED.
 5. REFER TO DRAWING NUMBER 146103/1008 FOR SIGN DETAILS

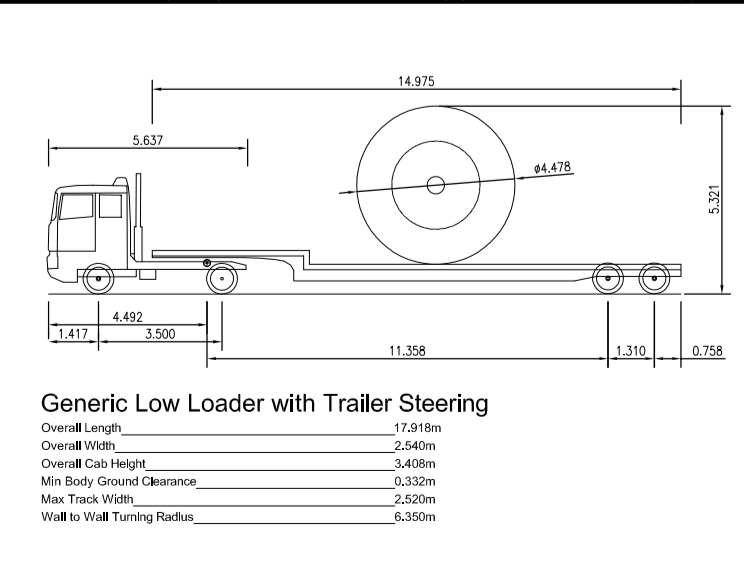

Client:

Project Title:
**EA3 HVDC ROUTE
PRE-COMMENCEMENT WORKS
TRANSPORT ASSESSMENT**

Drawing Title:
**NEWBOURNE ROAD ACCESS ROUTE
TO AP-H AND AP-I**

Westerton of Craigie,
Southampton Road, DUNDEE, DD4 7PN
Tel: 01382 453300 Fax: 0844 381 4412

Scale at A1: 1:2500	Status: FOR APPROVAL
Drawn: SC	Checked: GAV
Date: 10/11/21	Date: 11/03/22
Approved: GAV	Date: 11/03/22

Drawing No.: **146103/1009** Revision: **A**

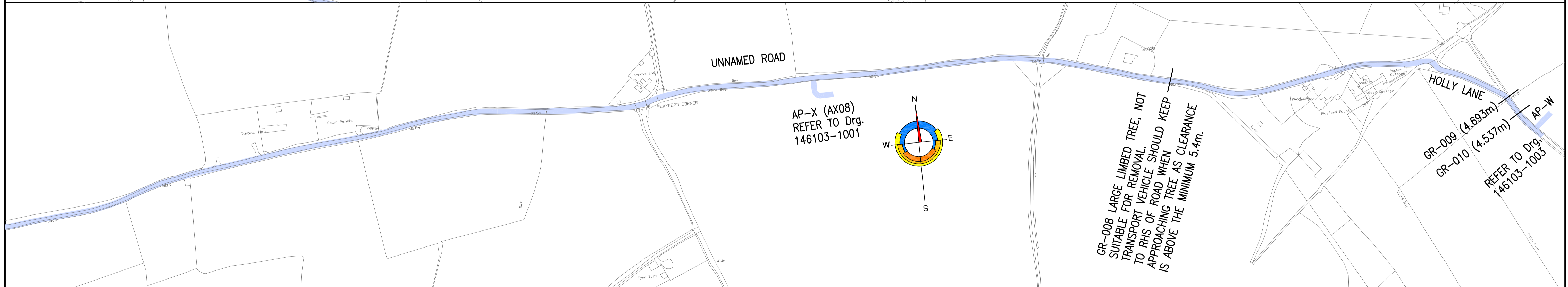
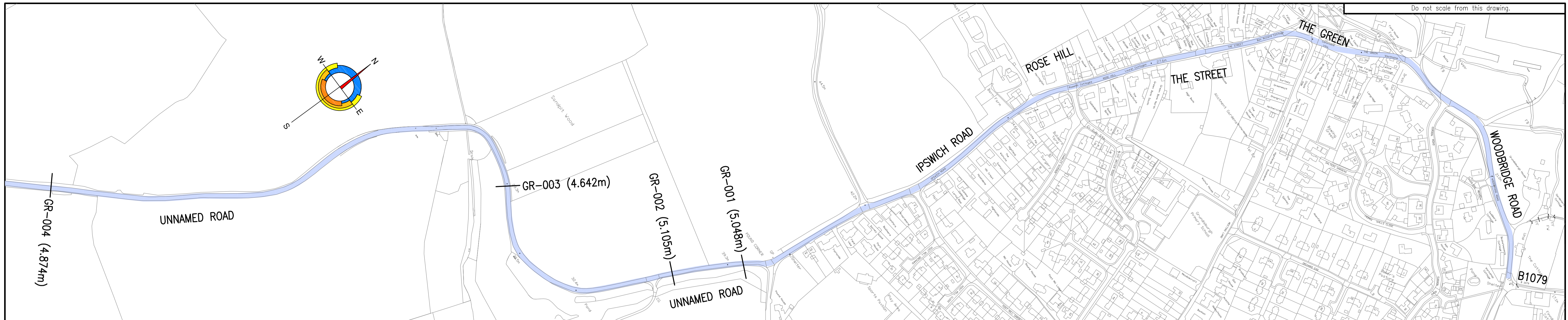

GR-008 LARGE LIMBED TREE, NOT SUITABLE FOR REMOVAL. TRANSPORT VEHICLE SHOULD KEEP TO RHS OF ROAD WHEN APPROACHING TREE AS CLEARANCE IS ABOVE THE MINIMUM 5.4m.

Rev.	Date	Description	Drawn	Checked	Approved

- Notes:
1. DENOTES ACCESS ROUTE FROM B1079.
 2. FOR DETAILED JUNCTION ARRANGEMENT AT AP-X, REFER TO DRAWING NUMBER 146103/1001
 3. FOR DETAILED JUNCTION ARRANGEMENT AT AP-W, REFER TO DRAWING NUMBER 146103/1003.
 4. GR..... DENOTES TREE SURVEY LOCATION WITH SURVEYED HEIGHTS TO BRANCHES IN BRACKETS.
 5. BASED ON AN ALLOWANCE OF 5.4m HEIGHT (CABLE DRUM ON LOW-LOADER) ANY TREE BRANCHES BELOW THIS HEIGHT SHOULD BE REMOVED.
 6. FOR ADVANCE WARNING SIGNS, REFER TO DRAWINGS NUMBER 146103/1001 AND 146103/1003

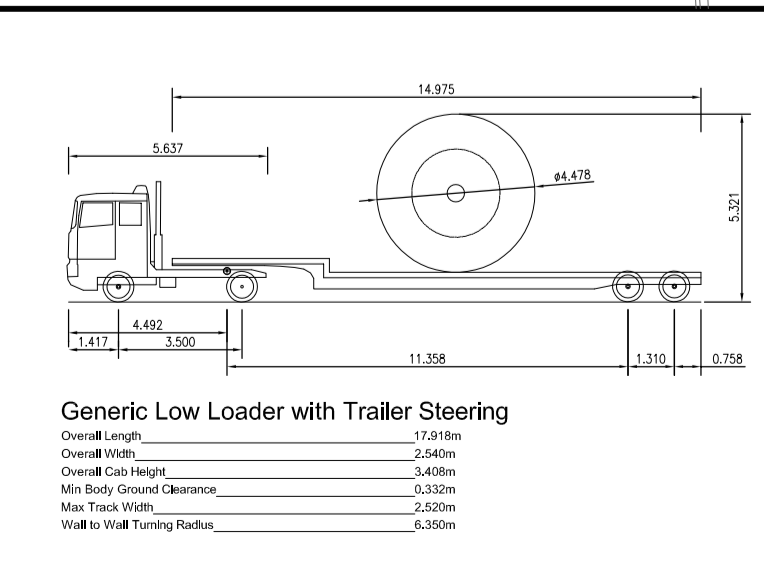

Client:

Project Title:
EA3 HVDC ROUTE
PRE-COMMENCEMENT WORKS
TRANSPORT ASSESSMENT

Drawing Title:
GRUNDISBURGH ROAD ACCESS
ROUTE TO AP-X AND AP-W

Westerton of Craigie,
Southampton Road, DUNDEE, DD4 7PN
Tel: 01382 453300 Fax: 0844 381 4412

Scale at A1: 1:2500	Status: FOR APPROVAL	
Drawn: SC	Checked: GAV	Approved: GAV
Date: 10/11/21	Date: 10/11/21	Date: 10/11/21
Drawing No.: 146103/1010	Revision: -	

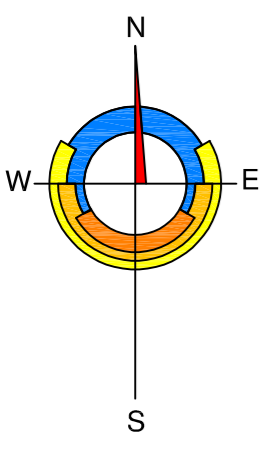

AP-G
REFER TO Drg,
146103-1000
AP-F



SCALE: 0 25m 50m 1:1250

Rev.	Date	Description	Drawn	Checked	Approved
A	25.04.22	SCALE CHANGED AND SCALEBAR ADDED. NOTES UPDATED.	GAV	ACM	SGD

Notes:

1. DENOTES ACCESS ROUTE FROM A14.
2. FOR DETAILED JUNCTION ARRANGEMENTS AT AP-F AND AP-G REFER TO DRAWING 146103/1000.

Client:

Project Title:
**EA3 HVDC ROUTE
PRE-COMMENCEMENT WORKS
TRANSPORT ASSESSMENT**

Drawing Title:
**A14 TO PAPER MILL LANE
ACCESS ROUTE
TO AP-F AND AP-G**

FAIRHURST

Westerton of Craigie,
Southampton Road, DUNDEE, DD4 7PN
Tel: 01382 453300 Fax: 0844 381 4412

Scale at A1: 1:1250	Status: FOR APPROVAL	
Drawn: ACM	Checked: GAV	Approved: GAV
Date: 12/11/21	Date: 12/11/21	Date: 12/11/21
Drawing No.:	Revision:	
146103/1011	A	

Do not scale from this drawing.

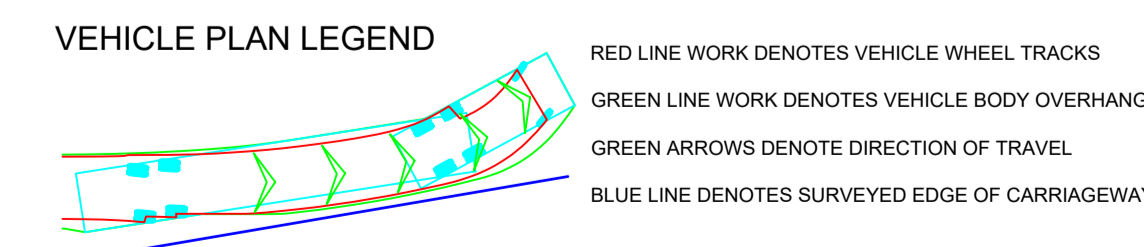
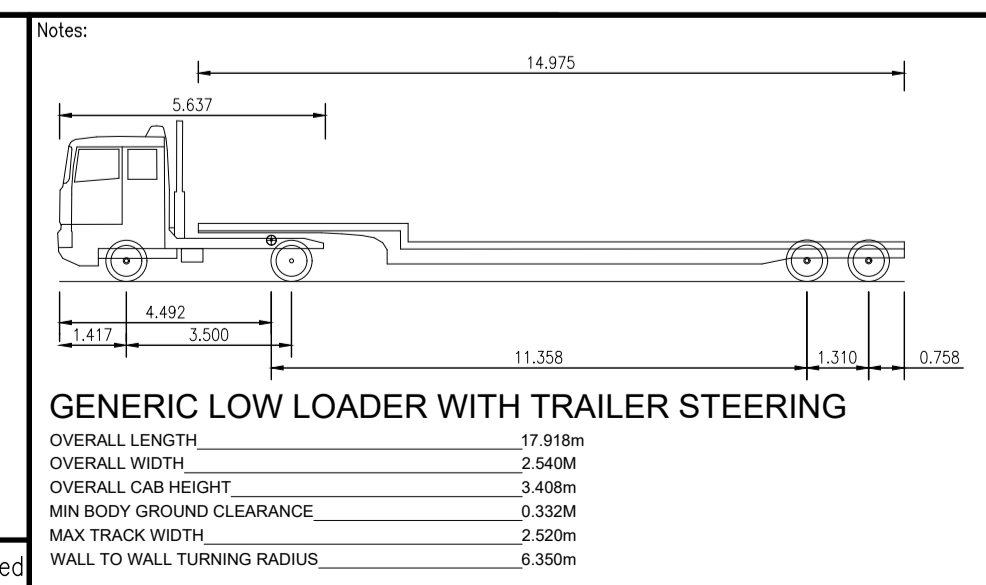
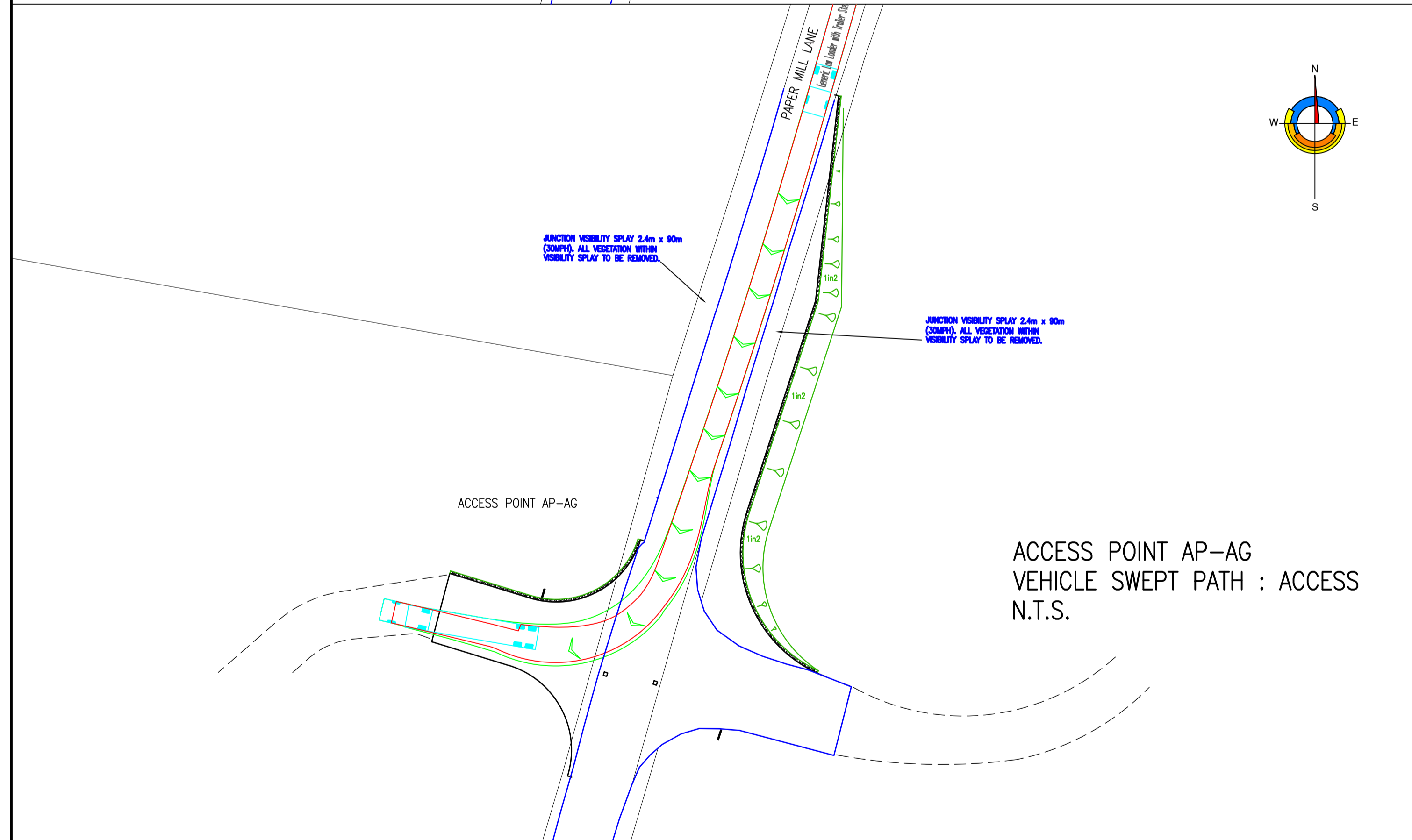
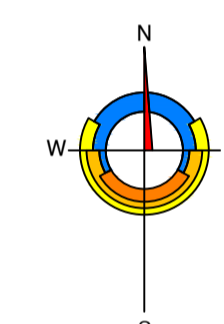
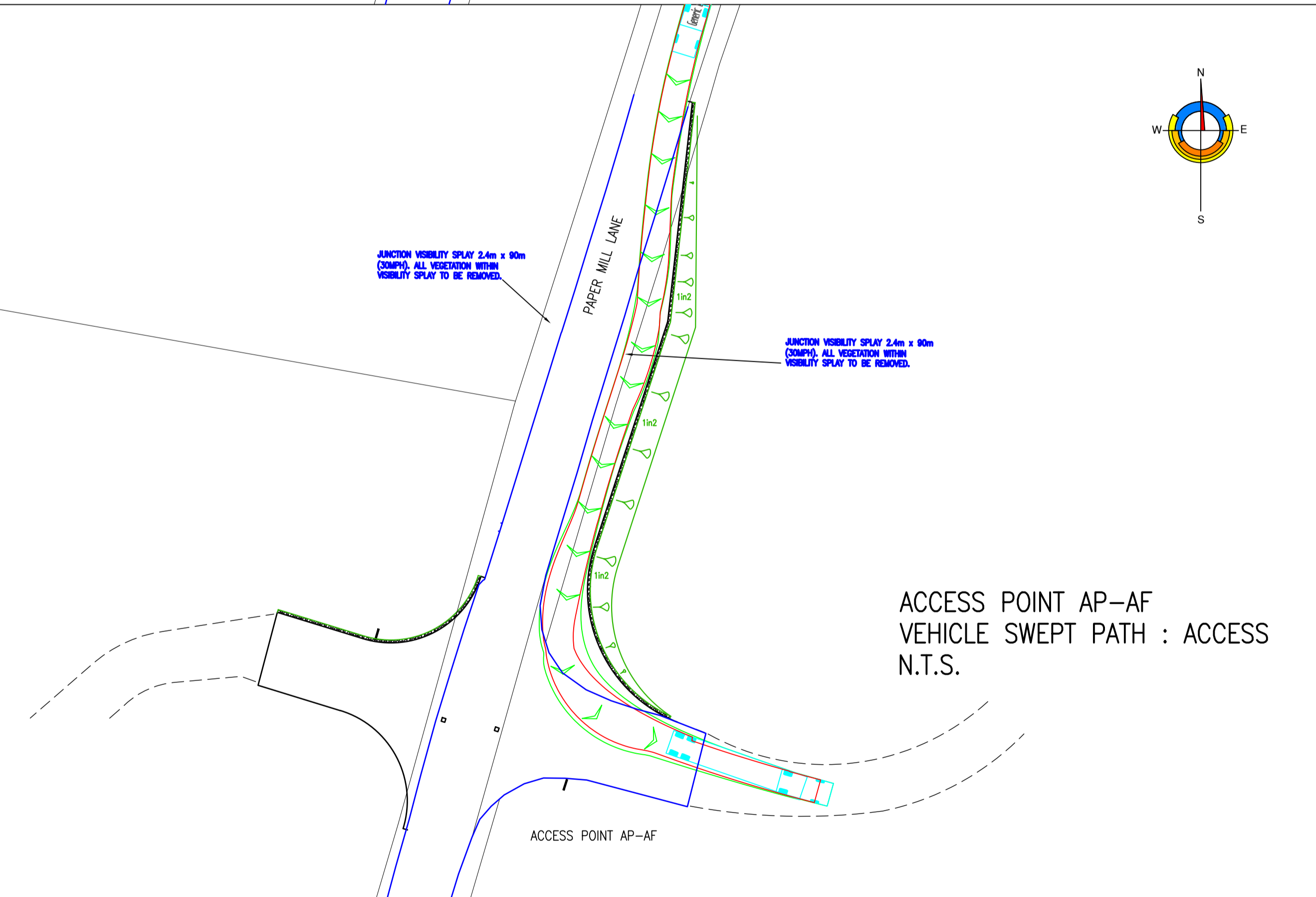
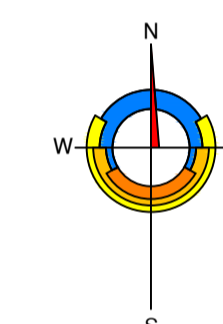
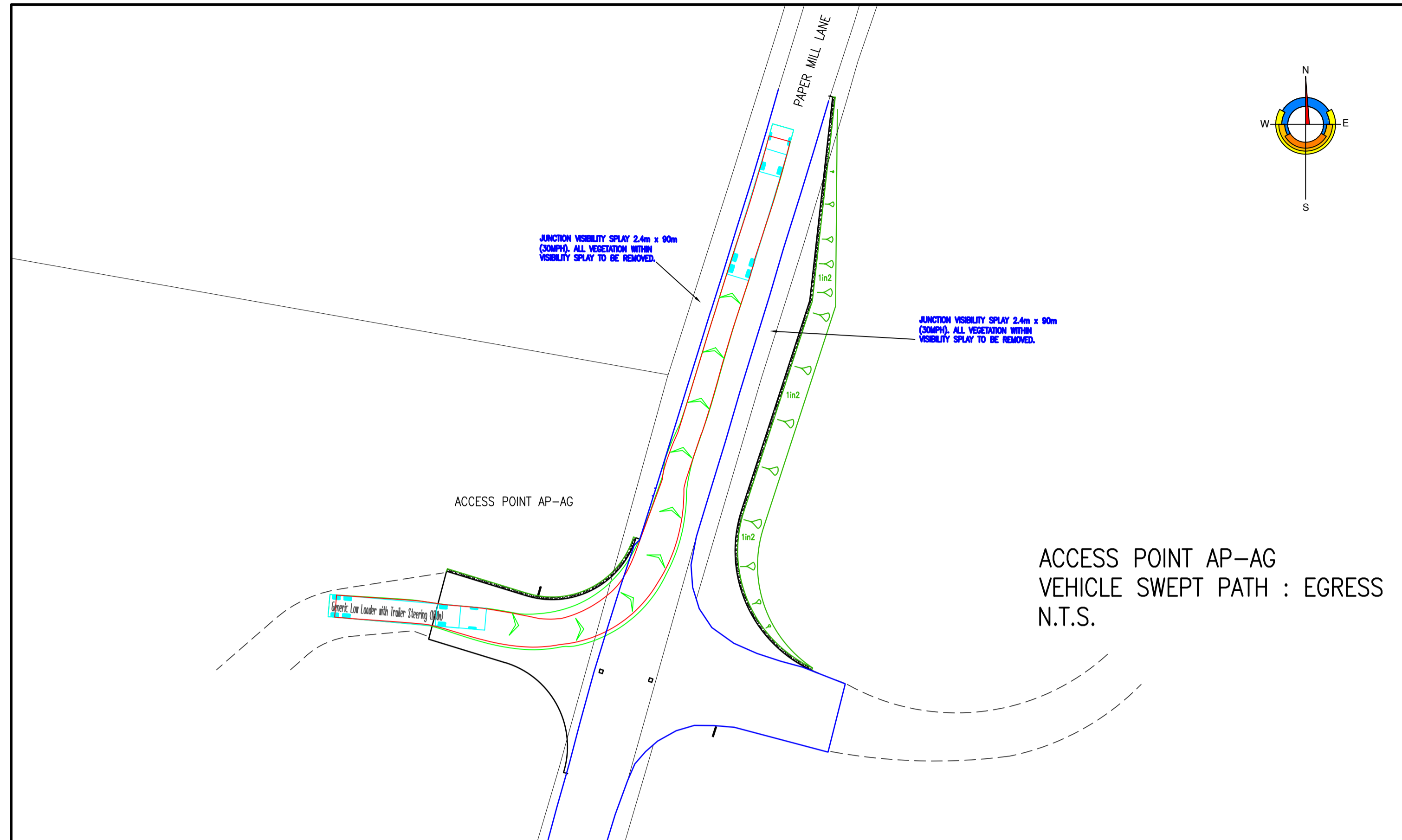
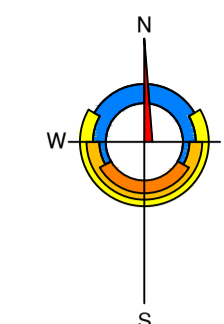
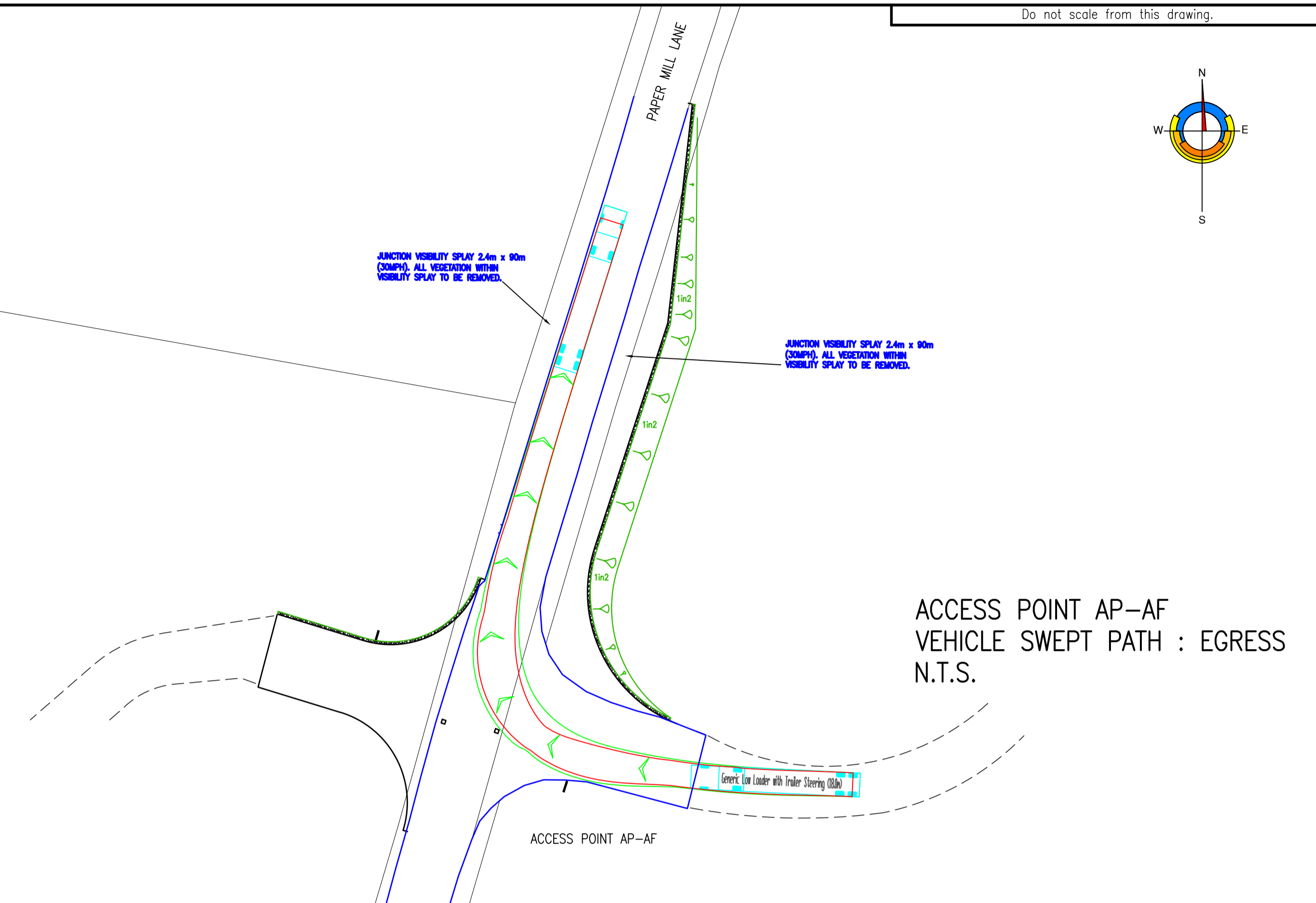
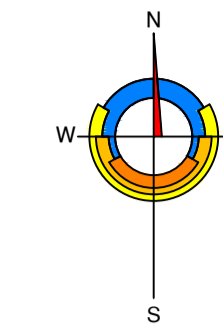

Rev.	Date	Description	Drawn	Checked	Approved

	Project Title: EA3 HVDC ROUTE PRE-COMMENCEMENT WORKS TRANSPORT ASSESSMENT		
	Drawing Title: SWEPT PATH ANALYSIS ACCESS POINTS AP-AF AND AP-AG	Scale at A1: Not to scale	Status: FOR APPROVAL
	Drawn: Date: 17/03/22	Checked: Date: 17/03/22	Approved: Date: 17/03/22
Drawing No.: 146103/1012		Revision: -	

NOTE:
THE PHOTOGRAPH OPPOSITE SHOWS THE WHEEL TRACKS ON BEALINGS ROAD AS A RESULT OF TRAFFIC MOVEMENTS IN AND OUT OF THE FORMER AX-08 JUNCTION USED DURING THE EA1 PROJECT, WHICH IS BEING REINSTATED TO THE EXACT SAME STANDARD FOR THIS EA3 PROJECT.

THE EXISTING BT POLE WITHIN THE NORTHERN VERGE OF BEALINGS ROAD IS SUITABLY DISTANCE FROM THE EXTENT OF THE LOW-LOADER VEHICLE SWEEP PATH, WHICH NEGATES THE REQUIREMENTS FOR ADDITIONAL PROTECTION MEASURES.

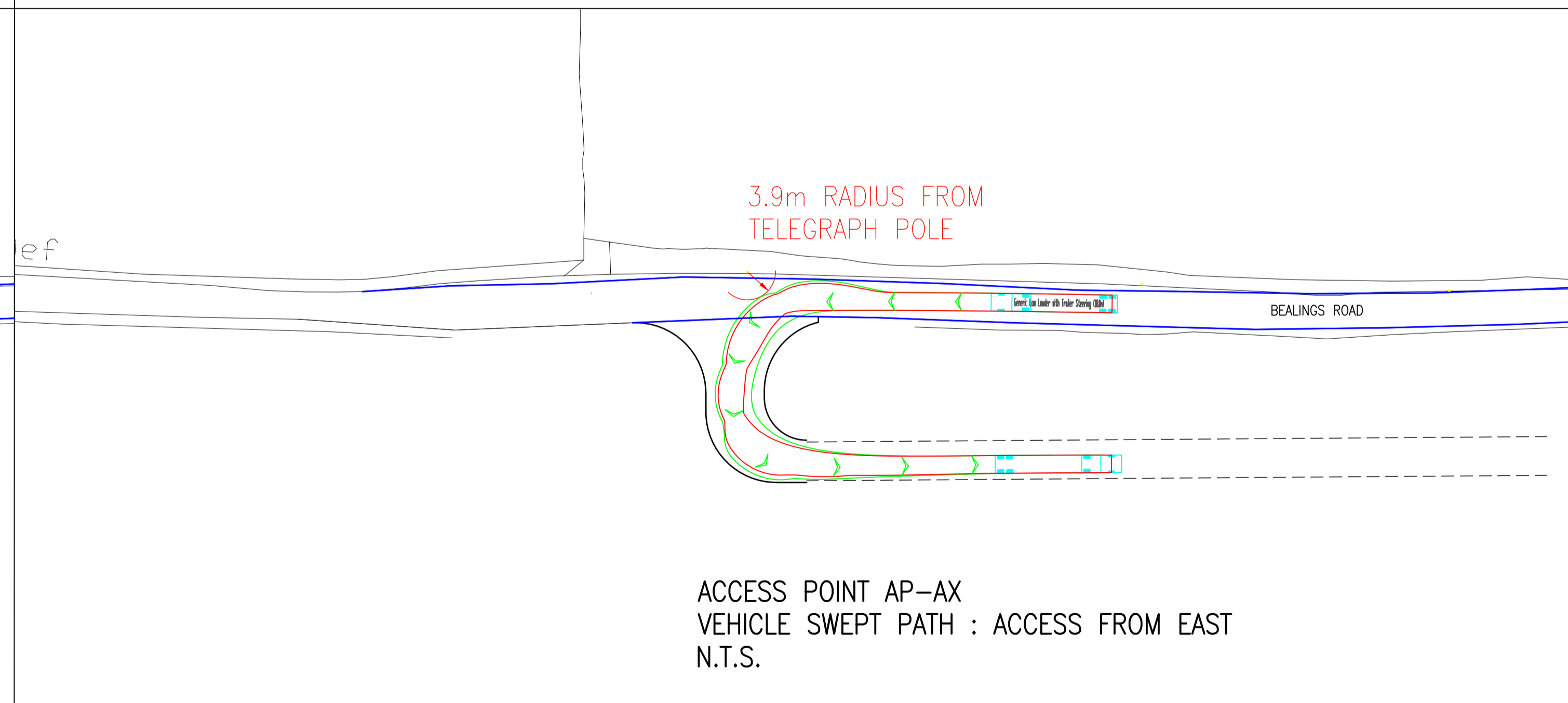
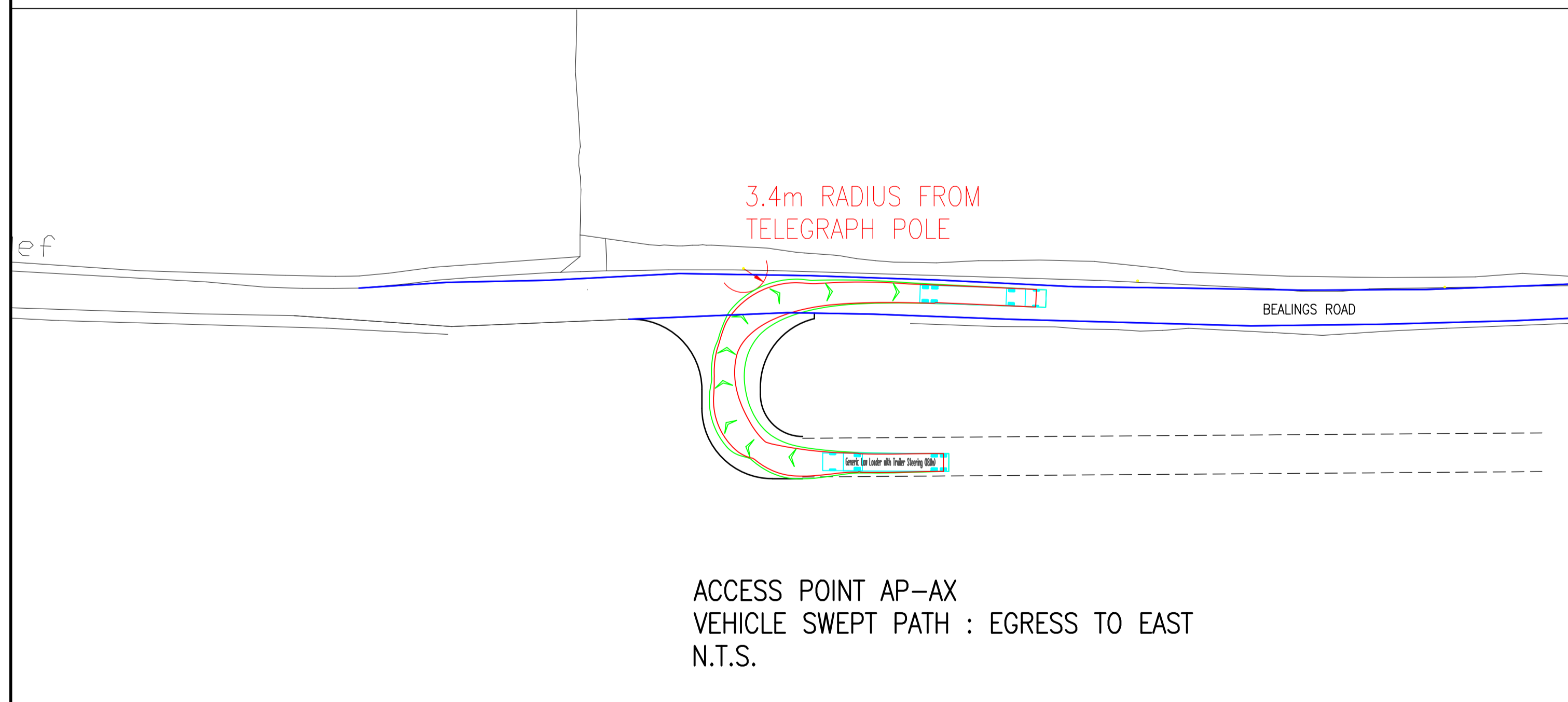
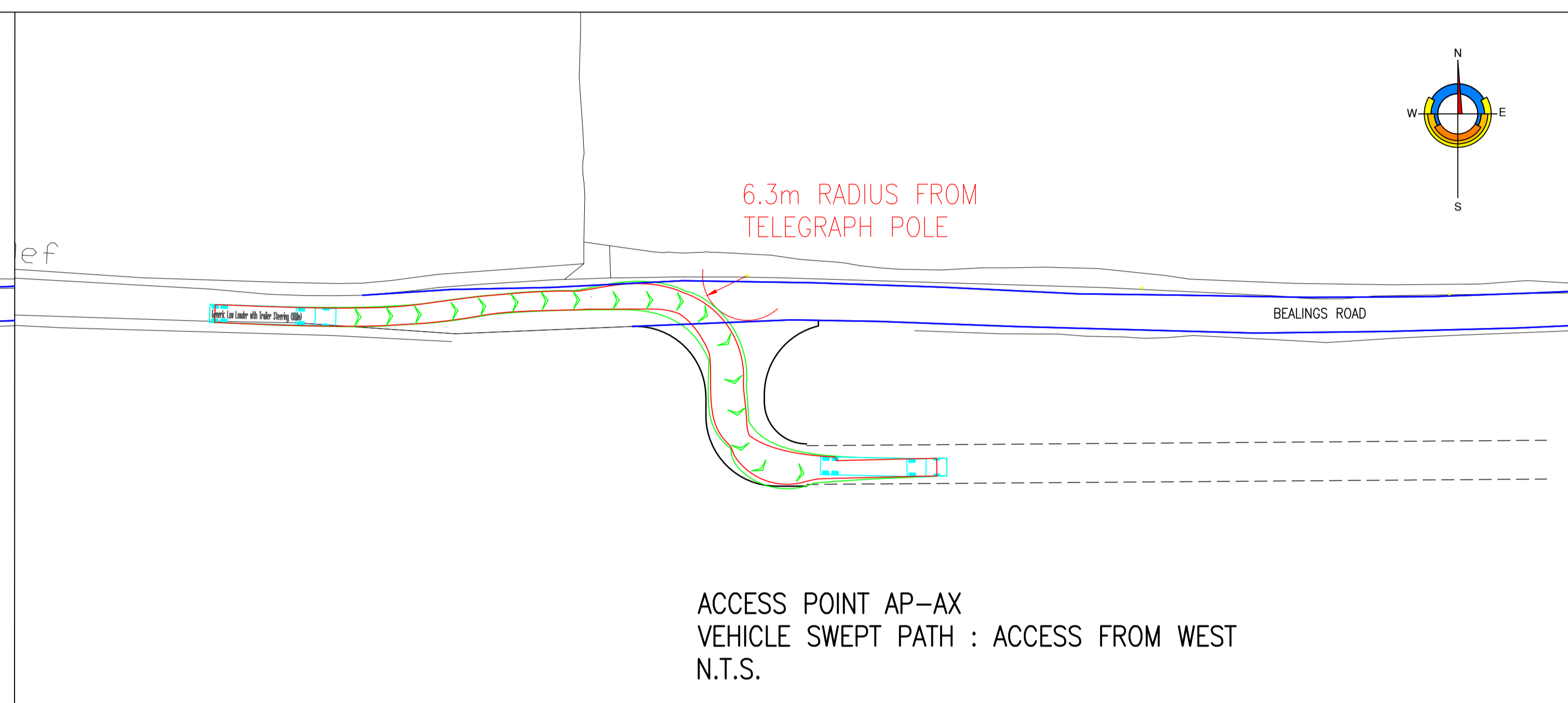
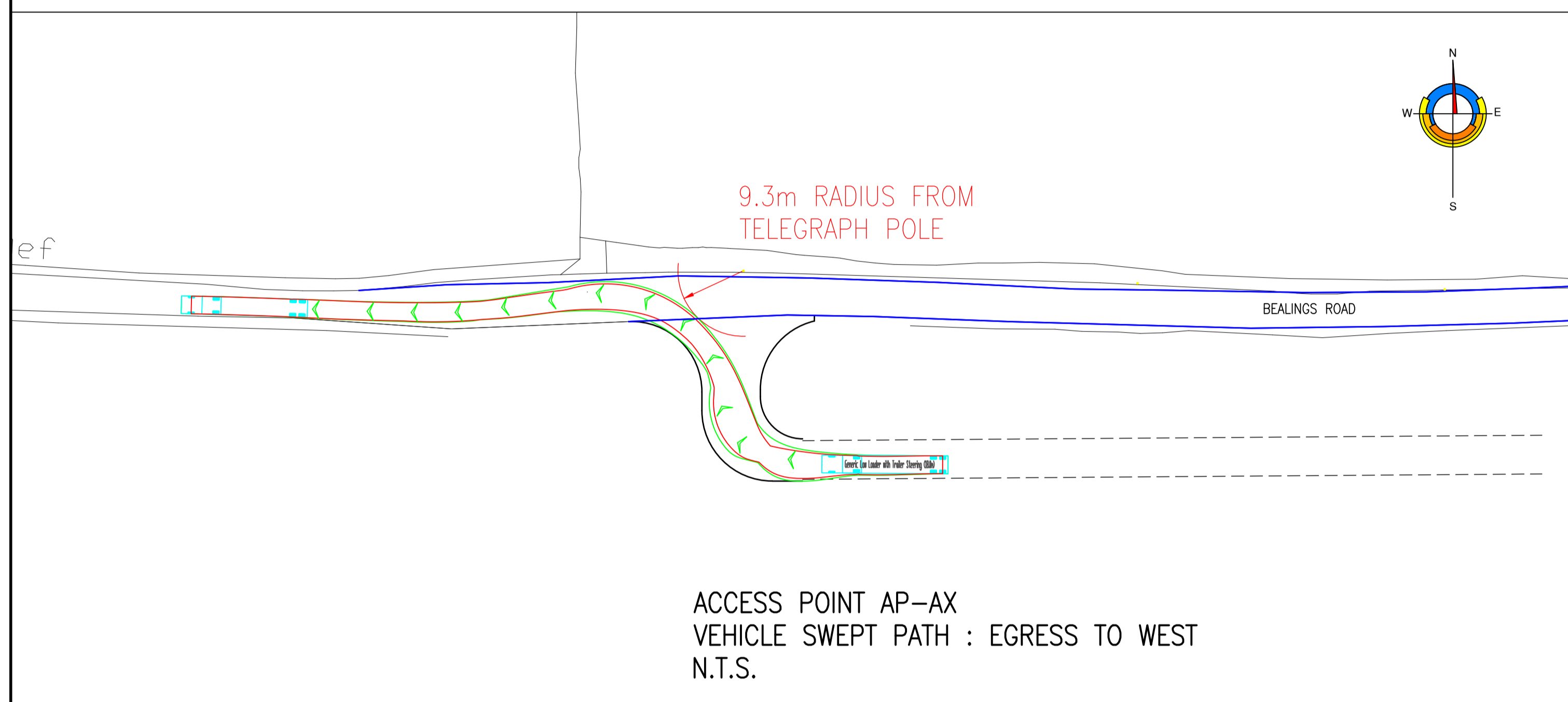

Rev.	Date	Description	Drawn	Checked	Approved
B	05.04.22	INFORMATION RELATING TO EXISTING TELEGRAPH POLE IN NORTHERN VERGE OF BEALINGS ROAD ADDED.	ACM	GAV	SGD
A	24.3.22	ACCESS AND EGRESS TO AND FROM THE EAST NOW SHOWN.	ACM	GAV	SGD

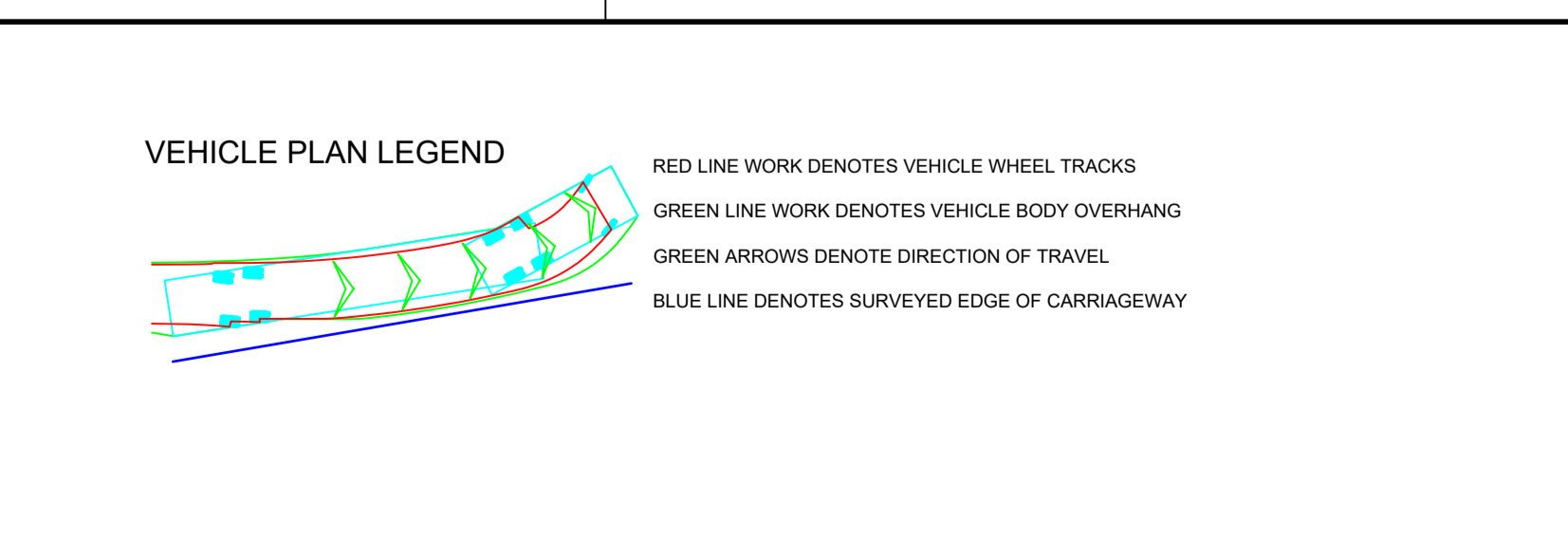
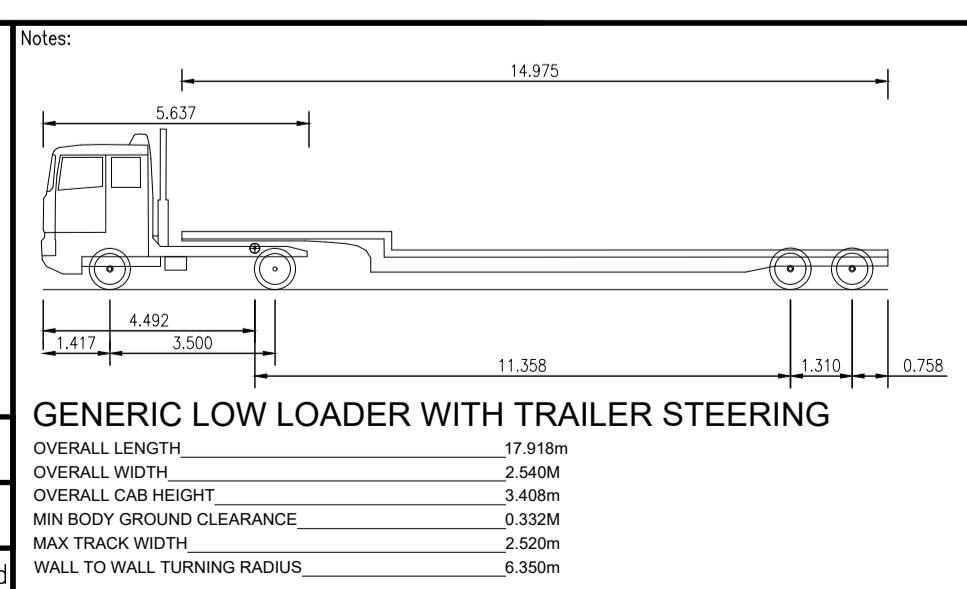

Client:

Project Title:

EA3 HVDC ROUTE
PRE-COMMENCEMENT WORKS
TRANSPORT ASSESSMENT

Drawing Title:
SWEEP PATH ANALYSIS
ACCESS POINT AP-X

FAIRHURST

Westerton of Craigie,
Southampton Road, DUNDEE, DD4 7PN
Tel: 01382 453300 Fax: 0844 381 4412

Scale at A1: Not to scale	Status: FOR APPROVAL	
Drawn: ACM	Checked: GAV	Approved: SGD
Date: 17/03/22	Date: 17/03/22	Date: 17/03/22
Drawing No.: 146103/1013	Revision: B	

Do not scale from this drawing.

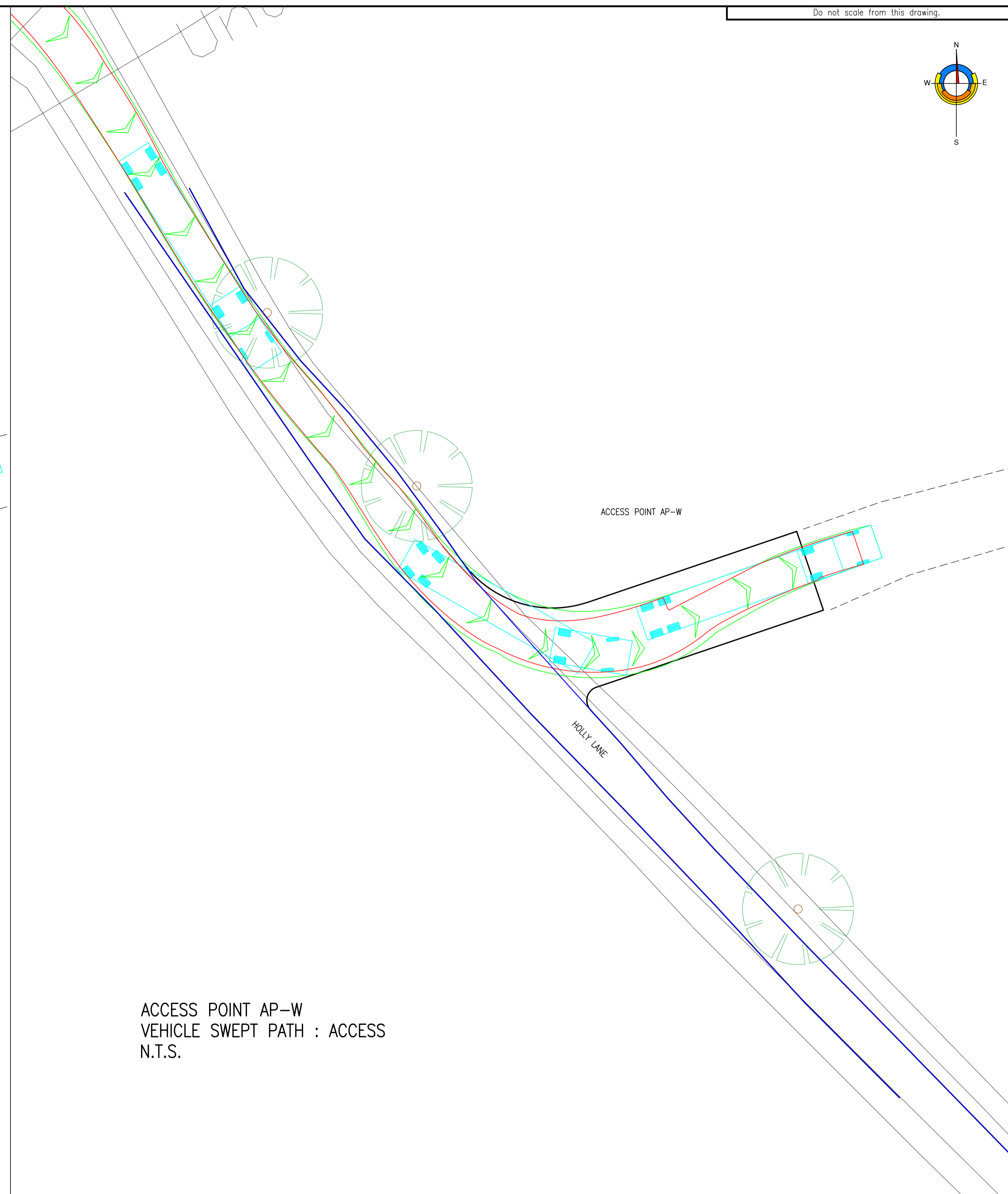
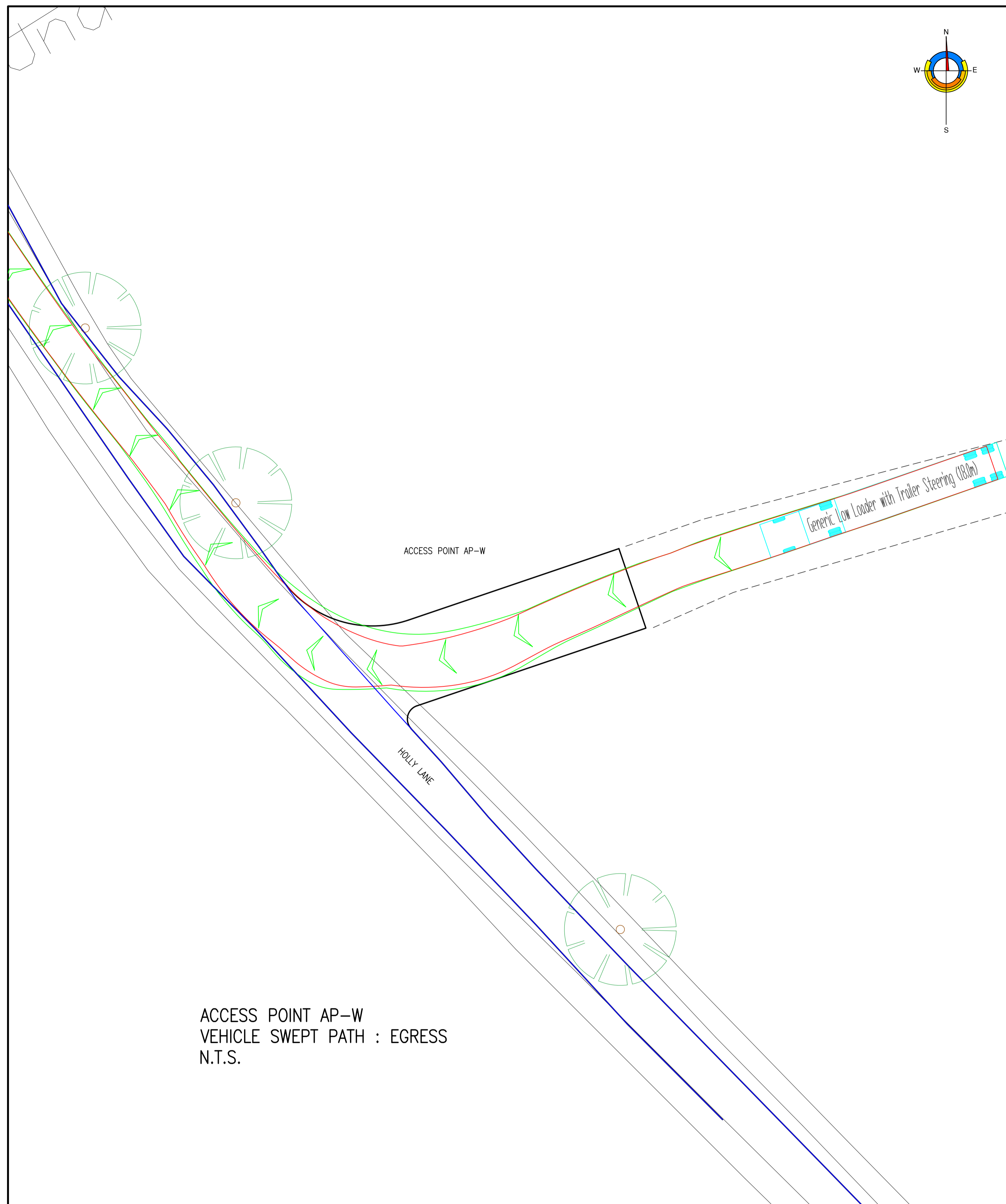
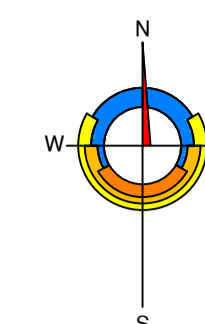
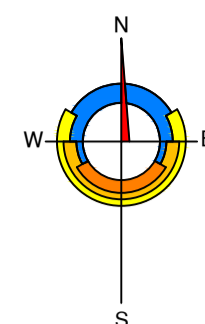

ACCESS POINT AP-W
VEHICLE SWEEP PATH : EGRESS
N.T.S.

ACCESS POINT AP-W
VEHICLE SWEEP PATH : ACCESS
N.T.S.

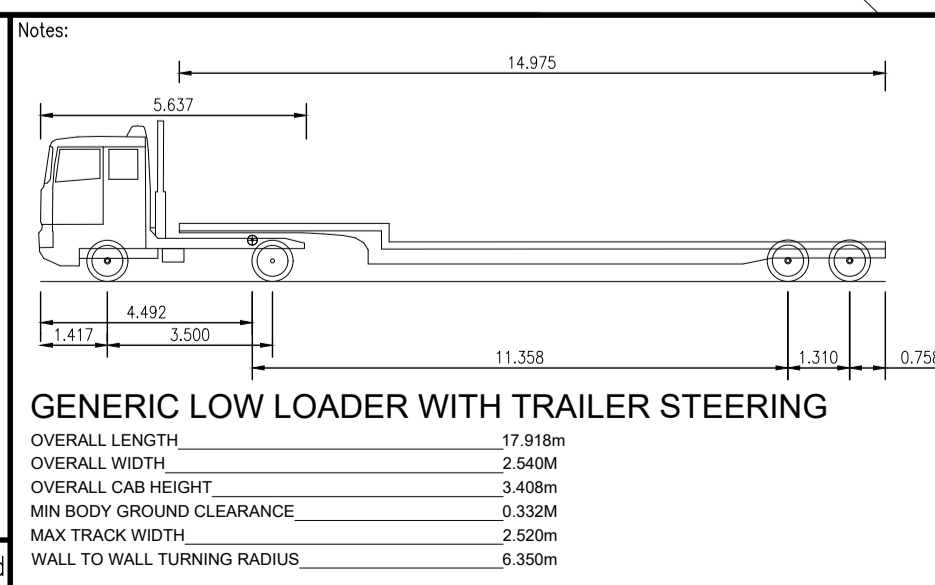

VEHICLE PLAN LEGEND

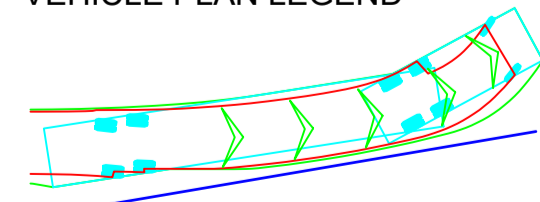

- RED LINE WORK DENOTES VEHICLE WHEEL TRACKS
- GREEN LINE WORK DENOTES VEHICLE BODY OVERHANG
- GREEN ARROWS DENOTE DIRECTION OF TRAVEL
- BLUE LINE DENOTES SURVEYED EDGE OF CARRIAGEWAY

Rev.	Date	Description	Drawn	Checked	Approved

Client:

Project Title:
**EA3 HVDC ROUTE
PRE-COMMENCEMENT WORKS
TRANSPORT ASSESSMENT**

Drawing Title:
**SWEPT PATH ANALYSIS
ACCESS POINTS AP-W**

FAIRHURST

Westerton of Craigie,
Southampton Road, DUNDEE, DD4 7PN
Tel: 01382 453300 Fax: 0844 381 4412

Scale at A1: Not to scale	Status: FOR APPROVAL	
Drawn: ACM	Checked: GAV	Approved: SGD
Date: 17/03/22	Date: 17/03/22	Date: 17/03/22
Drawing No.: 146103/1014		Revision: -

Do not scale from this drawing.

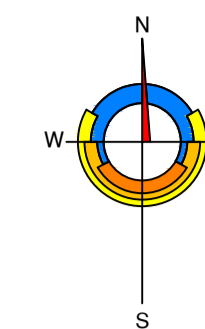
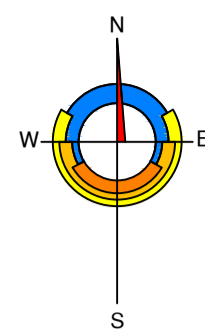

JUNCTION VISIBILITY SPLAY 2.4m x 90m (30MPH). ALL VEGETATION WITHIN VISIBILITY SPLAY TO BE REMOVED.

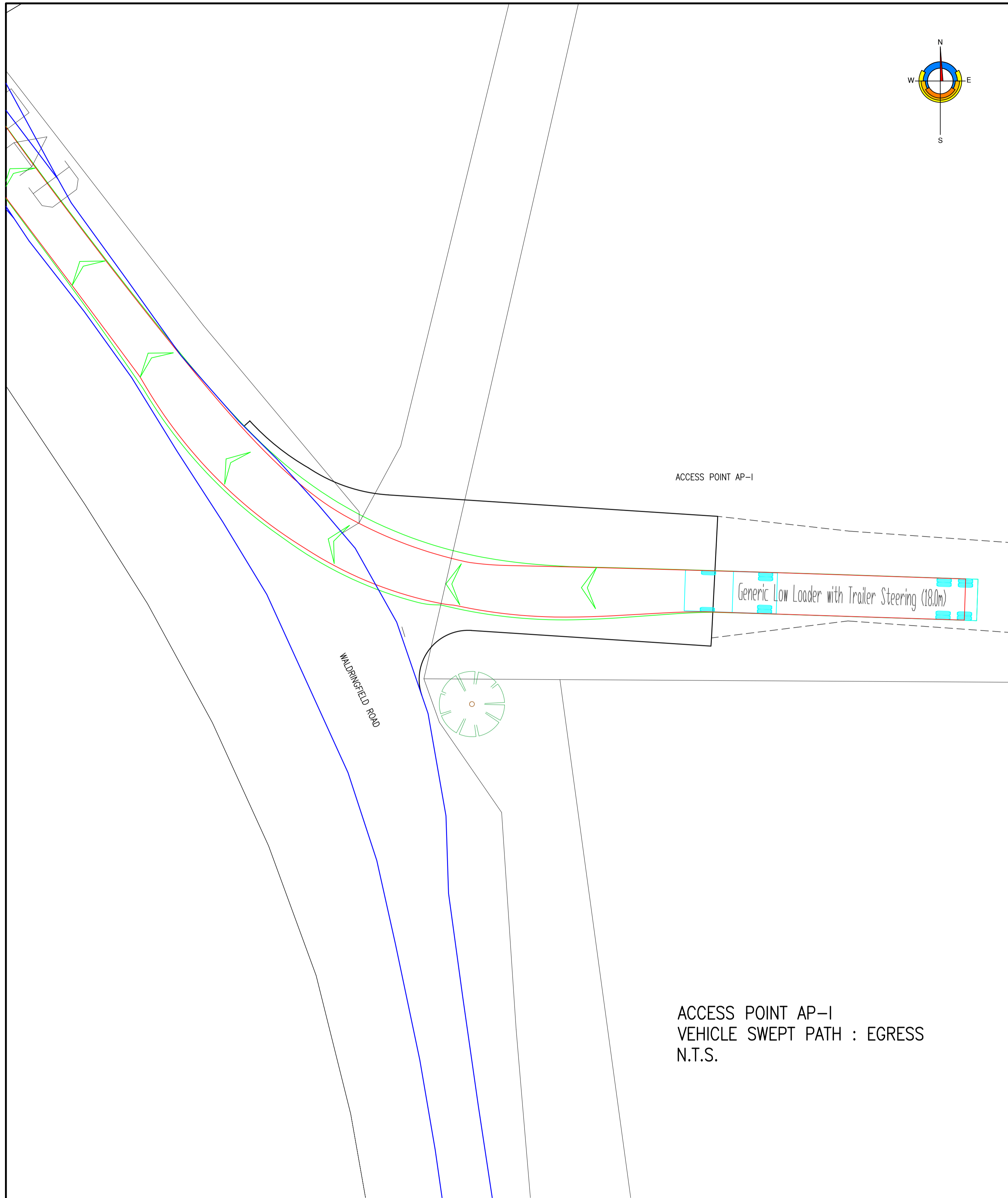

ACCESS POINT AP-1

Generic Low Loader with Trailer Steering (18.0m)

WILDRINGFIELD ROAD

ACCESS POINT AP-1
VEHICLE SWEEP PATH : EGRESS
N.T.S.

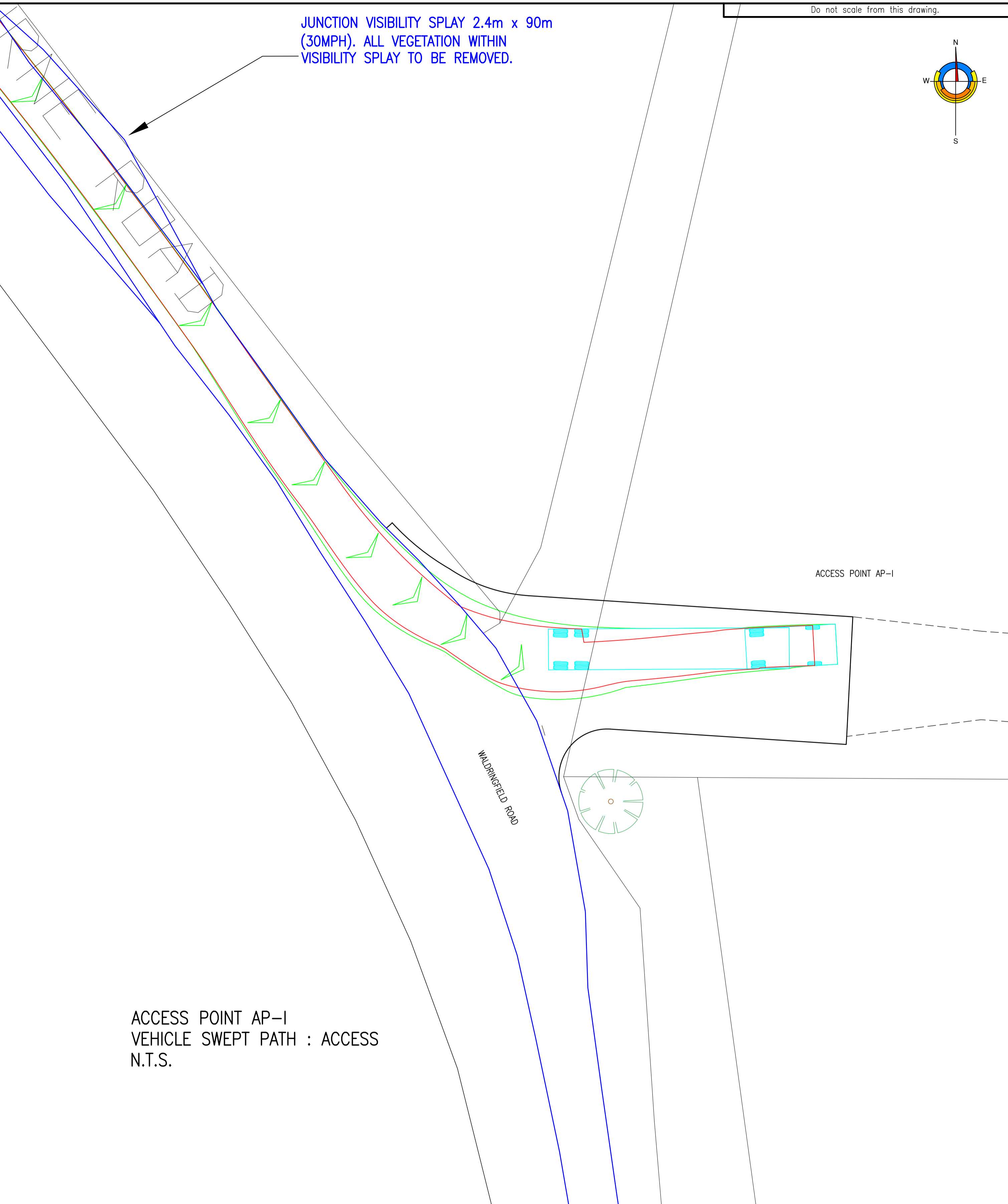

ACCESS POINT AP-1

WILDRINGFIELD ROAD

ACCESS POINT AP-1
VEHICLE SWEEP PATH : ACCESS
N.T.S.

Rev.	Date	Description	Drawn	Checked	Approved

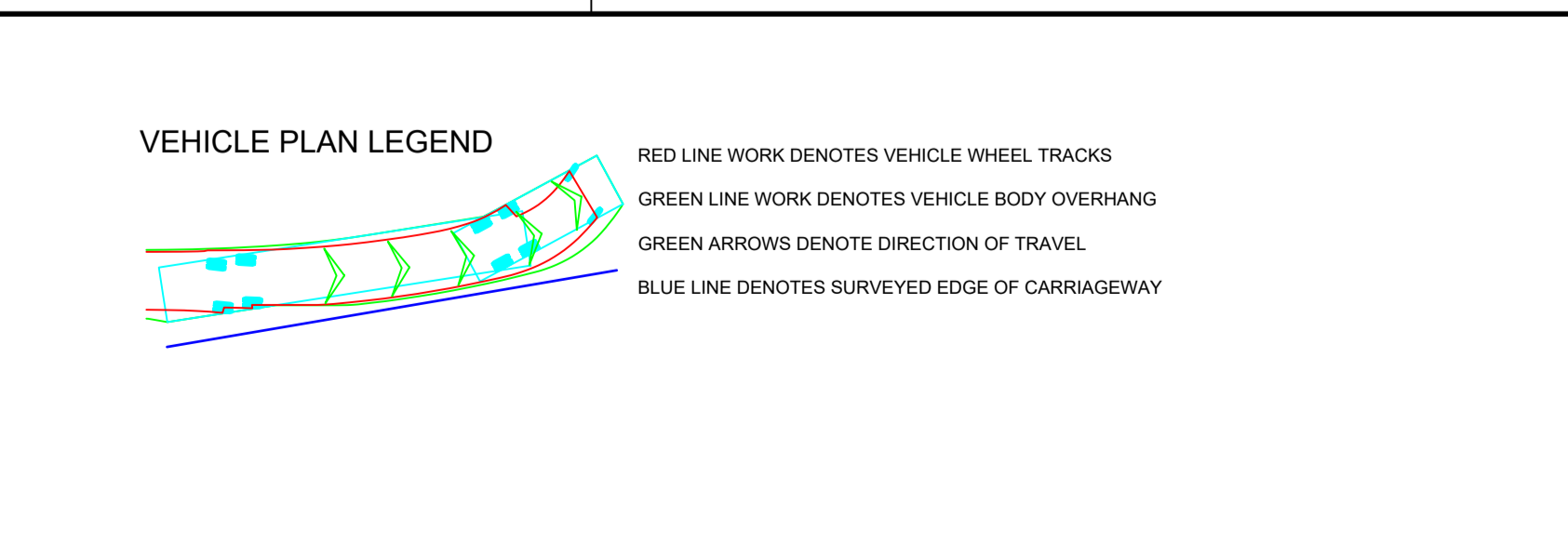
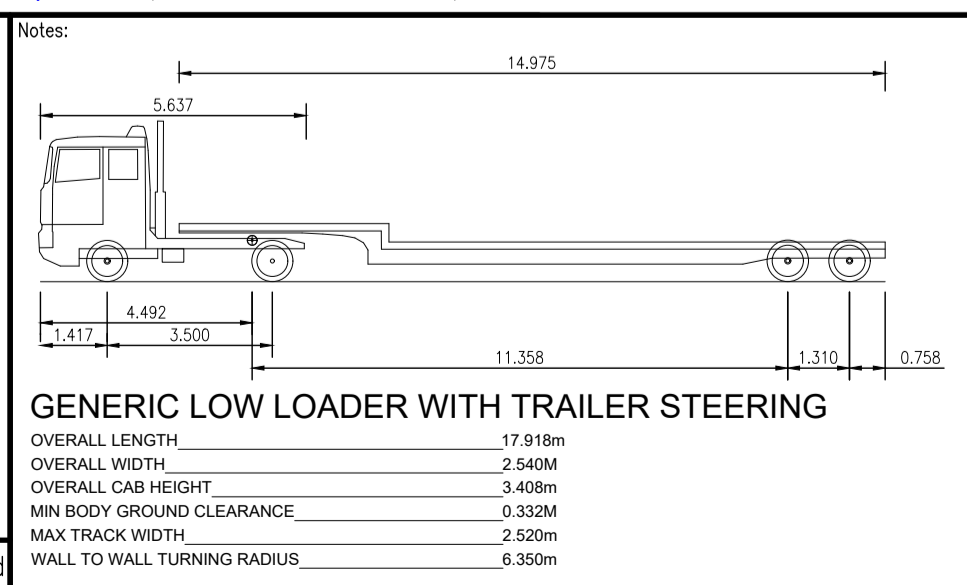

Client:

Project Title:
**EA3 HVDC ROUTE
PRE-COMMENCEMENT WORKS
TRANSPORT ASSESSMENT**

Drawing Title:
**SWEEP PATH ANALYSIS
ACCESS POINTS AP-1**

FAIRHURST

Westerton of Craigie,
Southampton Road, DUNDEE, DD4 7PN
Tel: 01382 453300 Fax: 0844 381 4412

Scale at A1: Not to Scale	Status: FOR APPROVAL	
Drawn: ACM	Checked: GAV	Approved: SGD
Date: 17/03/22	Date: 17/03/22	Date: 17/03/22
Drawing No.: 146103/1015		Revision: -

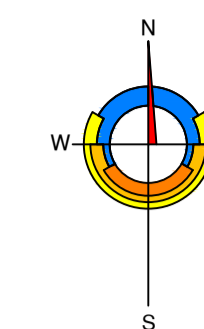
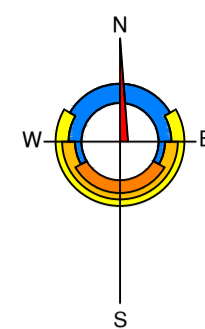

BLUE LINE WORK DENOTES THE EDGE OF EXISTING CARRIAGEWAY OBTAINED BY TOPOGRAPHIC SURVEY DATED 04 NOVEMBER 2021.
THE SWEEP PATH ANALYSIS INDICATES THAT FOR THE WORST CASE VEHICLE (LOW-LOADER), THE WHEEL TRACKS ARE CONTAINED WITH THE CARRIAGEWAY SURFACING, WITH NO IMPACT ON THE PRIVATE ACCESS DIRECTLY OPPOSITE ACCESS POINT AP-H.

BLUE LINE WORK DENOTES THE EDGE OF EXISTING CARRIAGEWAY OBTAINED BY TOPOGRAPHIC SURVEY DATED 04 NOVEMBER 2021.
THE SWEEP PATH ANALYSIS INDICATES THAT FOR THE WORST CASE VEHICLE (LOW-LOADER), THE WHEEL TRACKS ARE CONTAINED WITH THE CARRIAGEWAY SURFACING, WITH NO IMPACT ON THE PRIVATE ACCESS DIRECTLY OPPOSITE ACCESS POINT AP-H.

ACCESS POINT AP-H

ACCESS POINT AP-H

ACCESS POINT AP-AH
VEHICLE SWEEP PATH : EGRESS
N.T.S.

ACCESS POINT AP-AH
VEHICLE SWEEP PATH : ACCESS
N.T.S.

NEBOURNE ROAD

NEBOURNE ROAD

Rev.	Date	Description	Drawn	Checked	Approved
B	06.04.22	NOTES REGARDING EXTENT OF TOPOGRAPHIC SURVEY ADDED, ALONG WITH CONFIRMING SWEEP PATH ANALYSIS DOES NOT IMPACT PRIVATE ACCESSES	ACM	GAV	SGD
A	24.03.22	EXISTING SERVICES INFORMATION REMOVED FROM DRAWING FOR CLARITY.	ACM	GAV	SGD

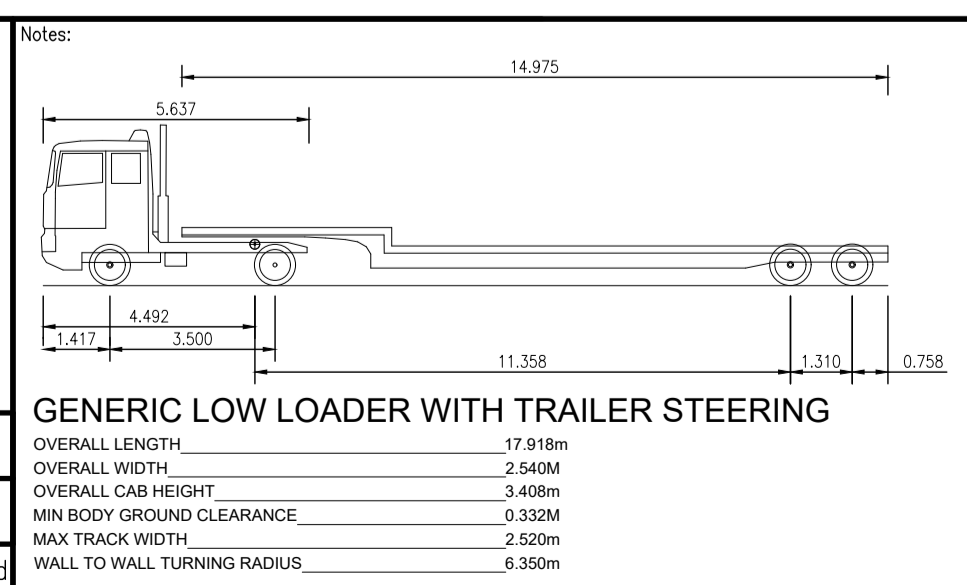

VEHICLE PLAN LEGEND

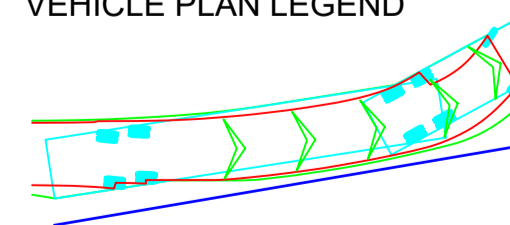

RED LINE WORK DENOTES VEHICLE WHEEL TRACKS
GREEN LINE WORK DENOTES VEHICLE BODY OVERHANG
GREEN ARROWS DENOTE DIRECTION OF TRAVEL
BLUE LINE DENOTES SURVEYED EDGE OF CARRIAGEWAY

Client:

Project Title:
EA3 HVDC ROUTE
PRE-COMMENCEMENT WORKS
TRANSPORT ASSESSMENT

Drawing Title:
SWEEP PATH ANALYSIS
ACCESS POINTS AP-H

FAIRHURST
Westerton of Craigie,
Southampton Road, DUNDEE, DD4 7PN
Tel: 01382 453300 Fax: 0844 381 4412

Scale at A1: Not to scale	Status: FOR APPROVAL	
Drawn: ACM	Checked: GAV	Approved: SGD
Date: 17/03/22	Date: 17/03/22	Date: 17/03/22
Drawing No.: 146103/1016		Revision: B

APPENDIX 2

146103-DOC-04 Method Statement for Traffic Control at Holly Lane

Project: East Anglia Three HV Cable Installation Highway Works	Job No.	146103
	Document Number	146103-DOC-04
	Prepared by/Date	ACM/13.04.2022
	Checked by/Date	GAV/13.04.2022
	Approved by/Date	GLB/13.04.2022

METHOD STATEMENT FOR THE TEMPORARY TRAFFIC CONTROL AT HOLLY LANE (AP-W).

The following Method Statement has been prepared in support of the application to Suffolk County Council for the construction of a new access junction off Holly Lane, in order to gain access for construction vehicles associated with the HV Cable installation for the East Anglia Three project.

Holly Lane is a rural two way road with low traffic volumes and is currently the subject of the national speed limit. There are grass verges to both sides of the road in the vicinity of the new access and no pedestrian footpaths. Pedestrians currently walk either on the verges where suitable or within the public carriageway.

The construction of access junction AP-W, off Holly Lane, has a requirement to retain the existing mature trees in the vicinity from an environmental perspective. Retention of the trees significantly reduces the junction visibility when exiting site.

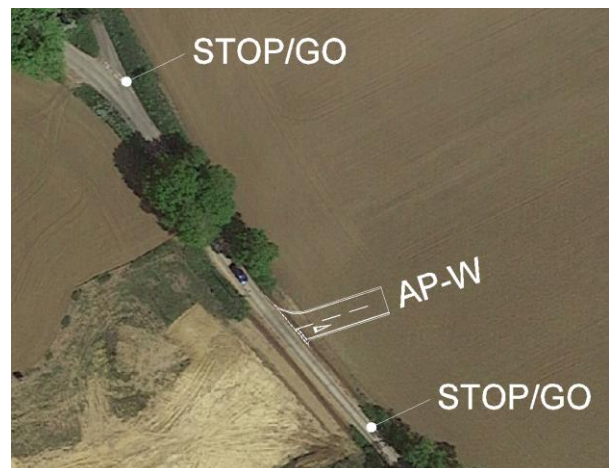

In order to mitigate against the reduced visibility upon exit from junction AP-W, a temporary traffic control system is being proposed, in the form of manually operated STOP/GO boards. The use of the STOP/GO boards will only be required for vehicles leaving the site access and turning right onto Holly Lane. No vehicles will be permitted to turn left out of AP-W.

For construction vehicles exiting junction AP-W, signage will be in place to highlight the requirements for drivers to stop at the junction and await further instruction to proceed once the STOP/GO system has been deployed, and they receive clear instruction from the operatives of the STOP/GO system that it is clear to exit.

The construction vehicle movements out of junction AP-W will be limited in number and sporadic. It is therefore proposed that vehicle movements are programmed so that operatives of the STOP/GO system are present.

Prior to implementing the STOP/GO system, Holly Lane will have the current speed limit reduced to 30mph, which will be instigated through a TTRO application to Suffolk County Council. In addition, advance warning signage will have been erected to warn road users of the presence of construction vehicles.

The live carriageway of any road is a dangerous environment in which to work. In particular, during the periods when traffic management arrangements are being set up, changed, maintained or removed, operatives will need to work on the live carriageway without the protection afforded by the fully installed layouts. This is particularly relevant on Holly Lane, as no footpaths are present. Only appropriately trained and competent operatives, supervisors, managers or other competent persons should be engaged in the, setting up, maintaining and removing of signing and temporary traffic control.

Due to the increased risk when setting up traffic management great care is needed to ensure that the operatives can see the traffic and the traffic can see them. High visibility clothing is to be worn at all times. When setting out the works, operatives should face oncoming traffic and keep to verges wherever possible. They should take particular care when crossing the road to place signs. They must not be distracted by mobile phones (including hands-free phones), radios, or other devices during the set-up operation.

The Department of Transport publication 'Safety at Street Works and Road Works' A Code of Practice, will be referred to for all information relating to the safe implementation and operation of this temporary traffic control. The 'Road Works Ahead' signs should be set up first. Using the appropriate diagrams in the aforementioned Code of Practice, operatives should work back towards the site, placing more signs as necessary again keeping to the verge wherever possible.

Manually operated STOP/GO boards are to be used in positions where the operator can be located in a position of safety. As the traffic management will only be implemented for the exit of a construction vehicle from AP-W, and then removed until required again, the use of remotely operated boards has been deemed as not appropriate.

Two STOP/GO boards will be in use each time. One to stop traffic on approach to AP-W from the south, and one to stop traffic on approach from the north. Operatives should remain in contact at all times using two-way radio communication. The operative showing 'Go' to oncoming traffic must always be the one to control the change of traffic flow. Adequate time must be allowed for vehicles to clear before the other board is reversed to show 'Go'.



On completion of the vehicles exit movement, operatives are to ensure that all signs are removed promptly. The signs should be taken down in reverse order to their erection ending with the 'Road works ahead' signs. Road Signs and STOP/GO boards should be stored in a secure container, located inside the site access gate.

Summary of Temporary Traffic Control

- Timings of vehicle movement existing the site are to be programmed.
- Erect additional signage in accordance with the 'Safety at Street Works and Road Works' Code of Practice.
- Deploy the STOP/GO boards.
- Once all construction traffic has left junction AP-W, remove all signage and STOP/GO boards and store in container at site access gate

Refer to 146103/FIGURE 1 for the arrangement of the STOP/GO boards to the north side of access point AP-W

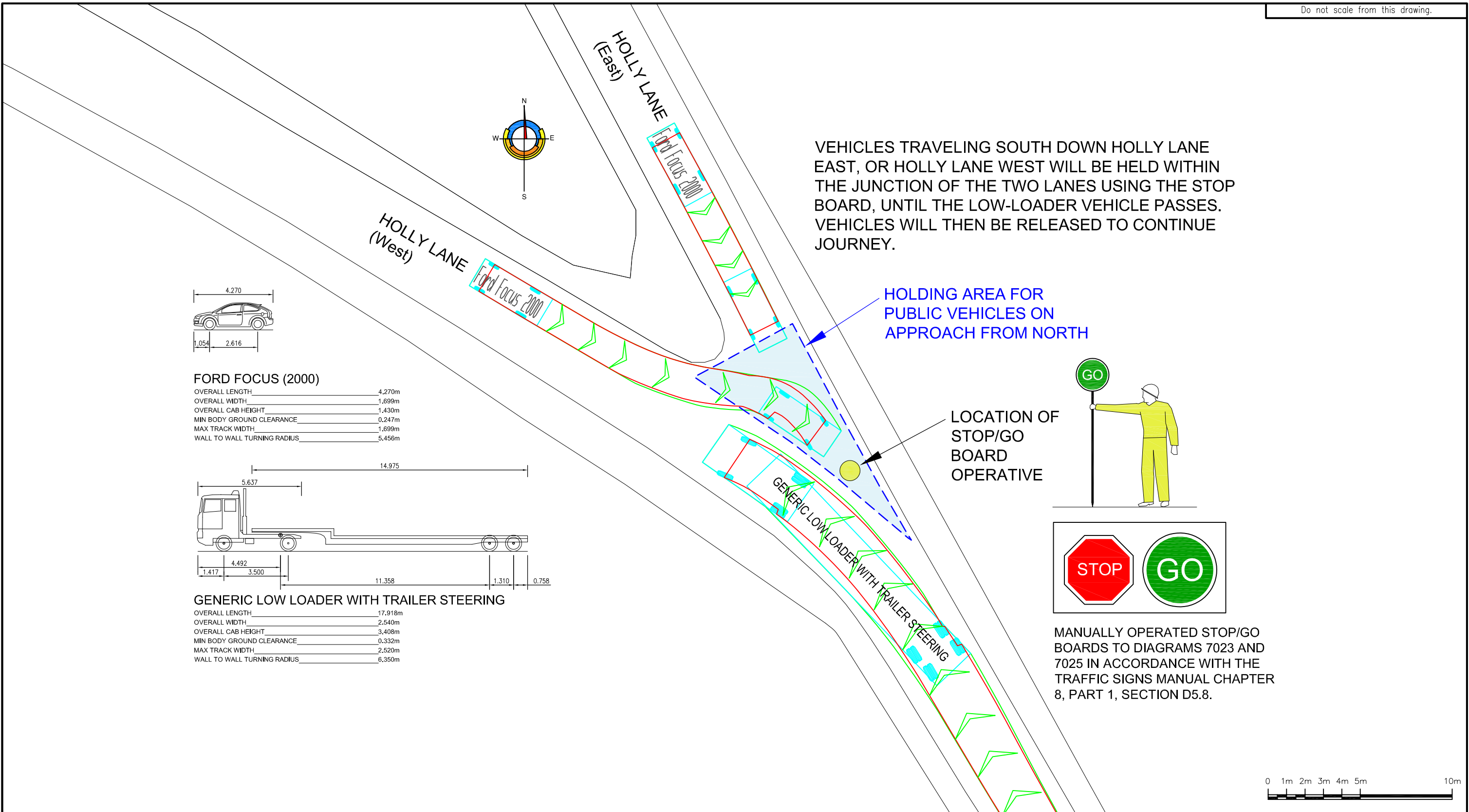

Notes:
 THIS FIGURE IS TO BE READ IN CONJUNCTION WITH THE METHOD STATEMENT 146103-DOC-04



Client:
 Project Title:
 EA3 HVDC ROUTE
 PRE-COMMENCEMENT WORKS
 TRANSPORT ASSESSMENT



Westerton of Craigie,
 Southampton Road, DUNDEE, DD4 7PN
 Tel: 01382 453300 Fax: 0844 381 4412



Drawing Title:
 STOP/GO BOARD ARRANGEMENT
 TO NORTH SIDE OF ACCESS
 POINT AP-W, HOLLY LANE.

Scale at A3: 1:200	Status: For Approval
Drawn: GAV	Checked: ACM
Date: 13/04/22	Date: 13/04/22
Approved: GLB	Date: 13/04/22
Drawing No.: 146103/FIGURE 1	Revision: -

Rev.	Date	Description	Drawn	Checked	Approved

CIVIL ENGINEERING • STRUCTURAL ENGINEERING • TRANSPORTATION • ROADS & BRIDGES
PORTS & HARBOURS • GEOTECHNICAL & ENVIRONMENTAL ENGINEERING • PLANNING &
DEVELOPMENT • WATER SERVICES • HEALTH & SAFETY / CDM SERVICES

www.fairhurst.co.uk

Aberdeen	Leeds
Birmingham	London
Bristol	Newcastle upon Tyne
Dundee	Plymouth
Edinburgh	Sevenoaks
Elgin	Taunton
Glasgow	Thurso
Huddersfield	Watford
Inverness	Westhill

FAIRHURST

**APPENDIX 2 NKT UK EA3 HVDC ROUTE COMMENCEMENT WORKS TRANSPORT
ASSESSMENT APRIL 2022**

FOR DISCHARGE

EAST ANGLIA THREE CONVERTER STATION AND PAPER MILL LANE WORKS

Traffic and Transport Technical Note
Prepared for: **ScottishPower Renewables**

SLR Ref: 404.05356.00006
Version No: Final
March 2022



BASIS OF REPORT

This document has been prepared by SLR with reasonable skill, care and diligence, and taking account of the manpower, timescales and resources devoted to it by agreement with ScottishPower Renewables (the Client) as part or all of the services it has been appointed by the Client to carry out. It is subject to the terms and conditions of that appointment.

SLR shall not be liable for the use of or reliance on any information, advice, recommendations and opinions in this document for any purpose by any person other than the Client. Reliance may be granted to a third party only in the event that SLR and the third party have executed a reliance agreement or collateral warranty.

Information reported herein may be based on the interpretation of public domain data collected by SLR, and/or information supplied by the Client and/or its other advisors and associates. These data have been accepted in good faith as being accurate and valid.

The copyright and intellectual property in all drawings, reports, specifications, bills of quantities, calculations and other information set out in this report remain vested in SLR unless the terms of appointment state otherwise.

This document may contain information of a specialised and/or highly technical nature and the Client is advised to seek clarification on any elements which may be unclear to it.

Information, advice, recommendations and opinions in this document should only be relied upon in the context of the whole document and any documents referenced explicitly herein and should then only be used within the context of the appointment.

CONTENTS

1.0	INTRODUCTION	1
1.1	Background	1
1.2	Purpose of the Report.....	1
2.0	DCO SUBMISSION EA3 CONVERTER STATION AND PAPER MILL LANE WORKS TRAFFIC DATA	3
2.1	Assessment Assumptions.....	3
2.2	Trip Generation.....	3
2.3	Assessment Requirements.....	4
3.0	REVISED EA3 CONVERTER STATION AND PAPER MILL LANE WORKS TRAFFIC DATA	6
3.1	Introduction	6
3.2	Trip Generation.....	6
3.3	Trip Distribution.....	6
4.0	ASSESSMENT OF LIKELY IMPACTS.....	8
4.1	Introduction	8
4.2	Assessment Parameters.....	8
4.3	Traffic Flows.....	8
4.4	Capacity Assessment.....	8
5.0	ROAD SAFETY ASSESSMENT REVIEW	10
5.1	Introduction	10
5.2	Scope	10
5.3	Analysis	10
5.3.1	A14/B1113 Claydon Interchange.....	10
5.3.2	B1113/Somersham Road	10
5.3.3	B1113/Bullen Lane	11
5.3.4	B1113/A1071.....	11
5.3.5	Paper Mill Lane	11
5.4	Summary.....	11
6.0	SUMMARY AND CONCLUSION	12
6.1	Summary.....	12
6.2	Conclusion.....	12

DOCUMENT REFERENCES

TABLES

Table 2-1 EA3 Converter Station, Paper Mill Lane Commencement Works and relevant cable works Trip Generation (DCO Submission)	3
Table 2-1 Forecast Evening Peak (17:00 – 18:00) Junction Impacts (DCO Submission).....	4
Table 3-1 EA3 Confirmed Maximum Figures (Siemens Energy and NKT)	6
Table 3-2 Forecast 17:00 – 18:00 Junction Impacts (Junction 1)	7
Table 4-1 ARCADY Results (17:00 to 18:00)	8

1.0 Introduction

1.1 Background

SLR Consulting Ltd. (SLR) has been commissioned by ScottishPower Renewables (SPR) to undertake a review and analysis of the anticipated vehicle movements associated with the construction of the East Anglia THREE (EA3) Converter Station and Paper Mill Lane Works, as per the Development Consent Order (DCO) dated 7th August 2017.

The forecast vehicle movements (personnel and Heavy Goods Vehicles (HGV)) for the construction of the EA3 Converter Station and cable works were set out in Chapter 27 'Traffic and Transport' of the Environmental Statement (ES), which was prepared by Royal HaskoningDHV in support of the DCO submission (Document Reference – 6.1.27)

The vehicle movements identified in the ES, which was prepared in 2015, were estimates based on a set of reasoned assumptions, professional experience and using previous project experience; however, Siemens Energy, who are the appointed Principal Contractor and will be responsible for construction of the EA3 Converter Station, has now confirmed the vehicle movements for the construction programme. NKT, the Principal Contractor for the EA3 cable route works, has provided confirmed vehicle movements associated with the Paper Mill Lane Works. These revised vehicle movements have been incorporated into the analysis presented in this Note.

Whilst this note relates to the construction vehicles associated with the Converter Station and Paper Mill Lane Works, it is acknowledged that during the main construction phase for the cable route in 2024, construction vehicles associated with the wider cable works will also be using the same road network. These vehicle movements, have also, therefore, been incorporated into the analysis presented in this note.

It should be noted that the ES referred to the construction of a substation; however, the proposal is now to construct a converter station. Therefore, all references to the converter station in this note are assumed to replace the references to the substation in the ES.

1.2 Purpose of the Report

The objective of this Technical Note is to provide Suffolk County Council (SCC) with an overview of the changes to the vehicle numbers associated with the construction of the EA3 Converter Station and Paper Mill Lane Works. Vehicle numbers and movements were discussed with SCC at a meeting on the 16th November 2021 and an initial draft of this note was provided following the meeting. The matter was discussed at the EA3 Traffic Working Group meeting on the 15th December 2021 and this note has been updated following the meeting and further discussions with SCC.

This Technical Note therefore sets out the following:

- A summary of the assessment assumptions and resulting vehicle numbers associated with the construction of the EA3 Converter Station, Paper Mill Lane Works and also relevant cable works identified in the ES;
- A summary of the assessment of vehicular impact associated with the construction of EA3, on the highway network in the ES;
- A summary of the potential assessment requirements of vehicular impact associated with the construction of EA3 on the highway network, following the issue of the DCO;
- A summary of the difference between the vehicle movements identified in the ES and the actual vehicle movements identified by Siemens Energy and NKT, based on a lower car occupancy than presented in the ES, for a robust assessment;

- A summary of the anticipated total vehicle movements associated with the construction of EA3 including the revised vehicle movements, at the locations potentially requiring assessment on the highway network;
- A review of the likely impacts at the sensitive junctions on the highway network that are likely to be used by traffic associated with the construction of the EA3 Converter Station and Paper Mill Lane Works (including for relevant cable works); and
- A summary of the above and a conclusion on assessment requirements for the consideration of SCC.

2.0 DCO Submission EA3 Converter Station and Paper Mill Lane Works Traffic Data

2.1 Assessment Assumptions

A brief summary of the assumptions employed to assess the impact of vehicle movements associated with the construction of EA3 is set out as follows:

- The nature of construction works typically requires that employees work longer hours in the summer and shorter hours in the winter to take advantage of the available daylight. Therefore, whilst employees would arrive prior to the morning network peak hour (08:00 to 09:00) throughout the year (and therefore no requirement for assessment during this period), there is the possibility that there would be an overlap between construction employees departing and the network evening peak hour (17:00 to 18:00 observed from traffic counts) i.e. when the daytime construction shift finishes at the same time as the evening network peak (employees would be departing their place of work and HGVs would be returning from making deliveries).
- As a worst case it was assumed that all employee trips would overlap with the evening network peak hour, recognising this scenario is only likely to occur during a two month period before and after the summer months.
- The delivery of materials and plant to the Primary CCSs (in this case Paper Mill Lane Works) would be spread over a ten hour period, whilst onward deliveries to Secondary CCSs or points of access would be scheduled to avoid network peak hours.
- A car occupancy of 2.5 employees per vehicle; and
- To develop a worst case impact scenario on the highway network, the peak traffic demand for each section was added together to create a theoretical 'in-combination worst case' week whereby the peak construction activity for all sections would occur concurrently. This results in the combined traffic flows on the 'A' class road network as over-estimated.

2.2 Trip Generation

The maximum number of employee, employee vehicle movements and HGV movements associated with the construction of the EA3 Converter Station, Paper Mill Lane Works and also relevant cable works identified in the ES as identified in Chapter 27 'Traffic and Transport', are set out in **Table 2-1** below:

Table 2-1
EA3 Converter Station, Paper Mill Lane Works
and relevant cable works Trip Generation (DCO Submission)

	Employees				HGV Movements	
	Number		Vehicle Movements		Daily	PM Peak
	Daily	PM Peak	Daily	PM Peak		
EA3 Converter Station	75	75	60	30	26	3
Paper Mill Lane Works and relevant cable works	150	150	120	60	131	13
Total	225	225	180	90	157	16

2.3 Assessment Requirements

In order to assess if there was any potential for significant impact the evening peak (17:00 to 18:00) on the highway network, the forecast construction traffic generation (EA3 Converter Station and Cable Route Sections 1 to 11) was assigned to the junctions across the agreed study area, to inform the DCO application.

SCC identified 11 junctions across the agreed study area as potentially being susceptible to increases in traffic flow.

In Chapter 27 'Traffic and Transport' it was concluded that the forecast vehicle movements associated with the construction of EA3 (total construction works) were of a magnitude that could potentially lead to significant impacts at the following three sensitive junctions:

- Junction 1: Roundabout junction of the A14 and B1113 (Claydon Interchange);
- Junction 5: Roundabout junction of the A12 and A1214; and
- Junction 11: Roundabout junction of the A12 and B1438.

In the Outline Construction Traffic Management Plan (OCTMP), prepared for the EA3 DCO application, the list of sensitive junctions where the forecast vehicle movements identified as having the potential to lead to significant impacts was as follows:

- Junction 5: Roundabout junction of the A12 and A1214;
- Junction 6: Roundabout junction of the A12 and Newbourne Road;
- Junction 8: Priority junction of the B1079 and Manor Road;
- Junction 11: Roundabout junction of the A12 and B1438; and
- Junction 12: Roundabout junction of the A14 and A12 (south)

The maximum vehicle movements (EA3 Converter Station and total EA3) in the evening peak hour at each of the junctions above (1, 5, 6, 8, 11 and 12) as identified in *Table 27.17 Peak Hour Traffic Flows through Sensitive Junctions* of Chapter 27 'Traffic and Transport', are set out in **Table 2-2**

Table 2-2
Forecast Evening Peak (17:00 – 18:00) Junction Impacts (DCO Submission)

Junction		Total EA3			EA3 Converter Station		
		Cars/LGVs	HGVs	Total	Cars/LGVs	HGVs	Total
1	A14/B1113	80	16	96	30	3	33
5	A12/A1214	88	22	110	0	0	0
6	A12/Newbourne Road	48	22	70	0	0	0
8	B1079/Manor Road	15	0	15	0	0	0
11	A12/B1438	134	22	156	0	0	0
12	A14/A12	52	24	76	11	1	12

As **Table 2-2** shows, vehicle movements associated with the construction of the EA3 Converter Station only impact at Junction 1: A14/B1113 Claydon Interchange and Junction 12: A14/A12.

Capacity assessments were not undertaken at any of the junctions listed above (in Chapter 27 and the OCTMP) as part of the DCO application; however, the following strategy was proposed:

- The junctions identified as having the potential to lead to significant impacts would be subject to detailed analysis through the development of the Traffic Management Plan, post-consent, when a contractor has been appointed and can inform outcomes; and
- Further analysis would seek to quantify the potential significance of these impacts and the scope of mitigation measures. Potential mitigation measures would focus on enhanced travel planning and restricting peak hour movements rather than physical junction improvements.

3.0 Revised EA3 Converter Station and Paper Mill Lane Works Traffic Data

3.1 Introduction

In the context of the strategy set out in **Section 2.3**, and using the assessment assumptions in Chapter 27 ‘Traffic and Transport’, the following text sets out the revised vehicle movements for the construction of EA3 as a result of the EA3 Converter Station vehicle movements anticipated by Siemens Energy and the Paper Mill Lane Works (and relevant cable installation works) vehicle movements anticipated by NKT.

Following discussion and written feedback from SCC provided on the 13th December 2021, the focus of the assessment is at Junction 1: A14/B1113 Claydon Interchange.

The assessment is based on the worst case, which is during the two-week concrete pour for the EA3 Converter Station, when there are a higher number of daily HGVs. The average number of daily HGVs associated with the construction of the EA3 Converter Station is anticipated to be two for the majority of the construction period, which is significantly less than that for the two-week concrete pour period.

3.2 Trip Generation

The revised maximum (daily and evening peak) number of employee, employee vehicle movements and HGV movements associated with the construction of the EA3 Converter Station, Paper Mill Lane Works and the relevant cable installation works (i.e. Sections 8 to 11 of the cable route – see Figure 1 of the Outline Access Management Plan) are set out in **Table 3-1**.

Table 2-1 This is based on a car occupancy of 1.5, which has been identified from lessons learnt from the EA2 / EA1N ES and Examination, advice from SCC and through discussions with Siemens Energy, who has suggested that a 2.5 car occupancy is unlikely to be achievable.

Table 3-1
EA3 Confirmed Maximum Figures (Siemens Energy and NKT)

Construction Phase	Employees				HGV Movements	
	Number		Vehicle Movements		Daily	PM Peak
	Daily	PM Peak	Daily	PM Peak		
Converter Station	130	130	174	87	68	8
Paper Mill Lane Works including relevant cable Installation works (Sections 8 to 11)	60	60	80	40	20	2
Total	190	190	254	127	88	10

3.3 Trip Distribution

The data presented in **Table 3-1** has been distributed at Junction 1: A14/B1113 Claydon Interchange) based on the assessment in the ES, which is summarised as follow:

- 97% of employee vehicles using Junction 1;

- 100% of HGVs using Junction 1;
- 78% of employee vehicles from / to A14 South;
- 19% of employee vehicles from / to A14 North;
- 70% of HGVs from / to A14 South; and
- 30% of HGVs from / to A14 North.

Therefore, the maximum number of vehicle movements associated with the construction of the EA3 Converter Station (Siemens Energy data), Paper Mill Lane Works and the relevant cable installation works (Sections 8 to 11) (NKT data) in the evening peak hour at Junction 1 is set out in **Table 3-2**.

Table 3-2
Forecast 17:00 – 18:00 Junction Impacts (Junction 1)

Arm	Converter Station (Siemens Energy)			Paper Mill Lane - Works (and relevant cable installation works (Sections 8 to 11) (NKT)		
	Cars/LGVs	HGVs	Total	Cars/LGVs	HGVs	Total
B1113	84	8	92	0	0	0
A14 North	0	2	2	0	1	1
Ipswich Road	0	0	0	0	0	0
A14 South	0	6	6	0	1	1
Paper Mill Lane	0	0	0	39	2	41

Whilst SCC has confirmed that Junction 1: A14/B1113 Claydon Interchange was not considered a sensitive junction at the time of the DCO submission, there have been a number of consented planning applications since 2015 that have vehicular movements impacting the junction. Therefore, SCC has requested that a capacity assessment is undertaken at Junction 1: A14/B1113 Claydon Interchange to assess the potential impact of the EA3 construction traffic, based on the confirmed vehicle movement data provided by Siemens Energy and NKT, which is set out in **Section 4.0**.

4.0 Assessment of Likely Impacts

4.1 Introduction

This section presents a capacity assessment of Junction 1: A14/B1113 Claydon Interchange to assess the potential impact of the EA3 construction traffic, based on the confirmed vehicle movement data provided by Siemens Energy and NKT.

4.2 Assessment Parameters

The assessment has been based on the following parameters:

- Evening Peak (17:00 to 18:00);
- 2023 assessment year derived from the capacity assessment output in the Transport Assessment submitted in support of the planning application for the extension to Port One Business and Logistics Park (Ref: DC/20/01175);
- Addition of committed development traffic (see **Appendix 01**); and
- Confirmed vehicle movement data provided by Siemens Energy and NKT as set out in **Table 3-2**

4.3 Traffic Flows

The resulting traffic flows for the following assessment scenarios are provided in **Appendix 02**:

- 2023 base + committed development; and
- 2023 base + committed development + EA3

4.4 Capacity Assessment

The ARCADY model presented in the Transport Assessment for DC/20/01175 has been replicated and updated following a review of the junction geometries and additional comments from SCC, and the results of the two assessment scenarios (including a plan showing the junction geometries) identified above are provided in **Appendix 03** and summarised in **Table 4-1** below.

Table 4-1
ARCADY Results (17:00 to 18:00)

Arm	2023 Base + Committed Development		2023 Base + Committed Development + EA3	
	RFC	Maximum Queue	RFC	Maximum Queue
Ipswich Road	0.41	0.7	0.44	0.8
A14 Northbound Off-slip	0.41	0.7	0.43	0.7
Paper Mill Lane	0.10	0.1	0.13	0.2
B1113 Bramford Road	0.64	1.7	0.72	2.5
A14 Southbound Off-slip	0.24	0.3	0.26	0.3

As **Table 4-1** shows, the junction operates well within its theoretical capacity in the base plus committed development scenario and continues to operate within its theoretical capacity with the addition of the EA3 vehicle movements, with negligible queues and spare capacity for additional vehicle movements.

5.0 Road Safety Assessment Review

5.1 Introduction

SCC also requested that the assessment of road safety presented in the ES be updated for the B1113 corridor and Paper Mill Lane, to ascertain if any additional mitigation measures are required and the review is presented in this section.

5.2 Scope

The Crashmap database¹ has been used to compare the number of accidents and any clusters, for the five year period prior to the DCO application (2011 to 2015) and the most recent five year period available excluding 2020 as traffic levels will have been unrepresentative of typical conditions due to the Covid-19 pandemic (2015 to 2019), at the following locations:

- A14/B1113 Claydon Interchange;
- B1113/Somersham Road;
- B1113/Bullen Lane;
- B1113/A1071; and
- Paper Mill Lane

As the images in **Appendix 04** show, there has been a reduction or no change in the number of accidents that have occurred during each five year period at all locations, with the exception of Paper Mill Lane. A further analysis has been provided below.

5.3 Analysis

5.3.1 A14/B1113 Claydon Interchange

The number of accidents at the junction within the most recent five year period is significantly less than the number of accidents in the five year period prior to the submission of the DCO application with a noticeable reduction on the Ipswich Road arm, which will be used by some NKT vehicles accessing Cable Route Section 8:

- 2011 to 2015 - 24 accidents; and
- 2015 to 2019 – 9 accidents

There have been three accidents on the B1113 arm in each of the five year periods. A review of the 2015 to 2019 data shows the three accidents (see the Crashmap reports in **Appendix 05**), which were in the vicinity of the give way line, were due to three separate causation factors; one with no other vehicles involved, one involving an agricultural vehicle and one involving four vehicles, which appears to have been a shunt. Therefore, it can be concluded that there is not a deficiency in the highway layout that an increase in vehicles associated with the construction of EA3 would exacerbate.

5.3.2 B1113/Somersham Road

There has been a reduction in the number of accidents in the vicinity of the B1113/Somersham Road junction, with none occurring in the most recent five year period:

¹ www.crashmap.co.uk

- 2011 to 2015 – 3; and
- 2015 to 2019 – 0

Therefore, it can be concluded that there are no road safety issues at this junction that an increase in vehicles associated with the construction of EA3 would exacerbate.

5.3.3 B1113/Bullen Lane

There have been no accidents at the B113/Bullen Lane junction in either of the five year periods. Therefore, it can be concluded that there are no road safety issues at this junction that an increase in vehicles associated with the construction of EA3 would exacerbate.

5.3.4 B1113/A1071

The number of accidents at the junction within the most recent five year period is half the number of accidents in the five year period prior to the submission of the DCO application:

- 2011 to 2015 – 8; and
- 2015 to 2019 – 4

All four accidents in the most recent five year period occurred in different locations at the junction and therefore there is unlikely to be any deficiencies in the highway layout that an increase in vehicles associated with the construction of EA3 would exacerbate.

Whilst there has been one accident in each five year period that involved a cyclist, given the reduction in the total number of accidents and since only 3% of employee vehicles are forecast to use this junction and no HGVs are permitted to use the junction, it can be concluded that there are no road safety issues at this junction that an increase in vehicles associated with the construction of EA3 would exacerbate.

5.3.5 Paper Mill Lane

The number of accidents at the junction within the most recent five year period has increased from the five year period prior to the submission of the DCO application:

- 2011 to 2015 – 0; and
- 2015 to 2019 – 2

A review of the 2015 to 2019 data (see the reports in **Appendix 05**) shows the accidents occurred in different locations; one accident was a shunt and one involved no other vehicles. Given the low number of accidents and separate locations and causation factors, it can be concluded that there are no road safety issues at this junction that an increase in vehicles associated with the construction of EA3 would exacerbate.

5.4 Summary

The review of road safety in this section would indicate that, in general, there has not been any worsening of road safety since the submission of the DCO application, with a significant improvement at key junctions that will be used by the majority of construction traffic.

Therefore, no changes to the measures proposed in the Traffic Management Plan are considered to be necessary.

6.0 Summary and Conclusion

6.1 Summary

This Technical Note sets out the anticipated maximum number of vehicle movements associated with the construction of the EA3 Converter Station, Paper Mill Lane Works and the relevant cable installation works (Sections 8 to 11) in the evening peak hour at Junction 1: A14/B1113 Claydon Interchange using confirmed data from Siemens Energy and NKT. The assessment is based on a lower (and more realistic) car occupancy of 1.5 employees, compared to the car occupancy of 2.5 used in the ES for the DCO application.

A junction capacity assessment has been undertaken to test the impact of the confirmed EA3 traffic data at Junction 1: A14/B1113 Claydon Interchange, using the most recent baseline traffic data available and incorporating vehicle movements associated with various committed developments. The assessment confirmed there would be no capacity issues at the junction with the addition of the EA3 vehicle movements.

A review of road safety on the routes that would be used by the construction traffic associated with the construction of the EA3 Converter Station, Paper Mill Lane Works and the relevant cable installation works (Sections 8 to 11) shows there are no road safety issues that would be exacerbated by an increase in traffic flows and that no changes to the measures proposed in the EA3 Traffic Management Plan are required.

6.2 Conclusion

As demonstrated, the impact of the revised EA3 Converter Station and Paper Mill Lane Works construction works traffic data is such that there would be no capacity issues at Junction 1: A14/B1113 Claydon Interchange and no impacts on road safety on the routes used by construction traffic.

In, conclusion, no further assessments on the highway network should be required prior to the commencement of construction associated with the EA3 Converter Station and Paper Mill Lane Works.

A separate Technical Note has been prepared to consider the impact on the highway network of the EA3 Works at Playford Corner and Clappits based on the confirmed traffic data provided by NKT.

APPENDIX 01

Committed Development Traffic Flows

APPENDIX 02

Assessment Scenario Traffic Flows

2023 Base + Committed Development (17:00 to 18:00)

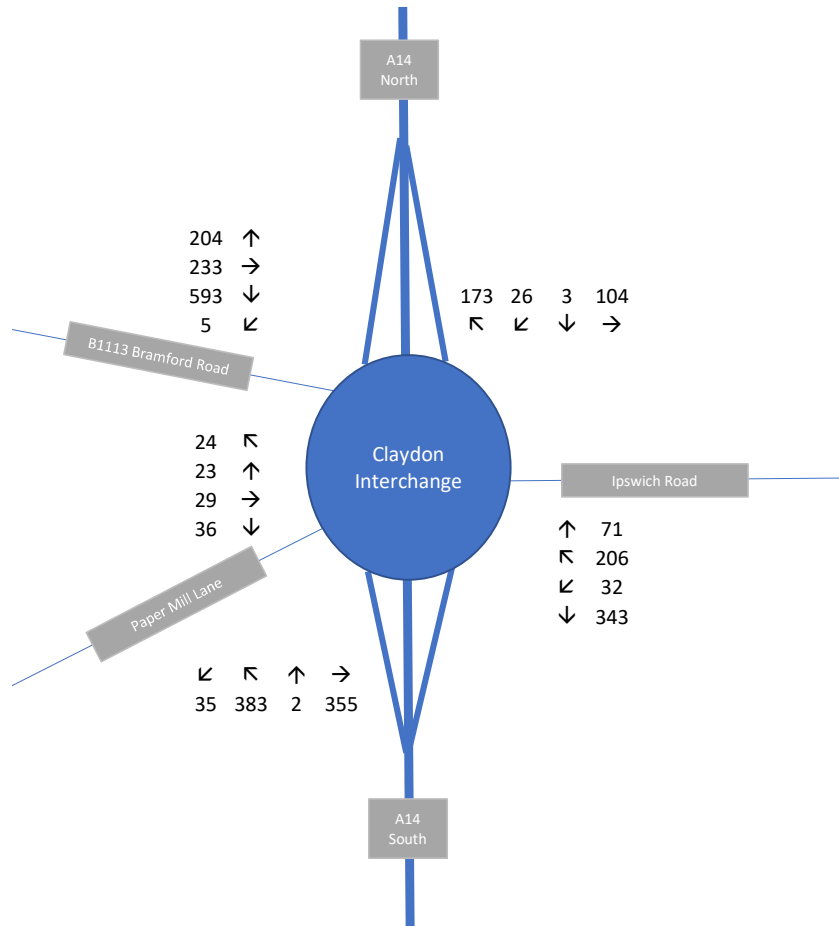

2023 Base + Committed Development + EA3 (17:00 to 18:00)

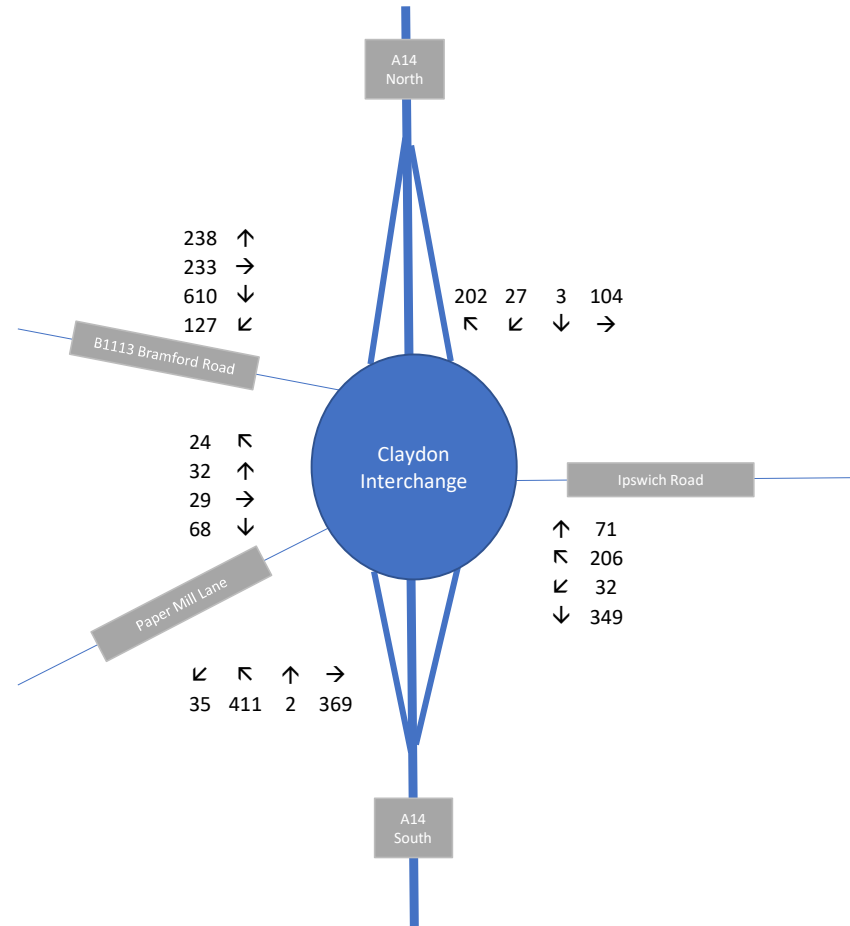

APPENDIX 03

ARCADY Results

Junctions 9
ARCADY 9 - Roundabout Module
Version: 9.5.1.7462 © Copyright TRL Limited, 2019
For sales and distribution information, program advice and maintenance, contact TRL: +44 (0)1344 379777 software@trl.co.uk www.trlsoftware.co.uk
The users of this computer program for the solution of an engineering problem are in no way relieved of their responsibility for the correctness of the solution

Filename: 20220208_A14_Claydon_PM_B1113_Single_Lane.j9
Path: \\euafs\SHEFS\SHE\AMA Sheffield\Projects\Scottish Power Renewables - 00481\404.05356.00006 - East Anglia offshore wind farms\EA3\B1113 Corridor TAs
Report generation date: 08/02/2022 13:57:42

- »2023 Base, AM
- »2023 Base, PM
- »2023 Base + Com Dev, PM
- »2023 Base + Com Dev + E3, PM

Summary of junction performance

	AM					PM				
	Set ID	Queue (Veh)	Delay (s)	RFC	LOS	Set ID	Queue (Veh)	Delay (s)	RFC	LOS
2023 Base										
Arm 1	D1	1.1	4.31	0.52	A	D2	0.7	3.33	0.40	A
Arm 2		0.6	2.86	0.38	A		0.6	2.75	0.38	A
Arm 3		0.1	3.26	0.11	A		0.1	2.99	0.09	A
Arm 4		2.0	8.59	0.67	A		1.6	7.35	0.62	A
Arm 5		0.3	3.35	0.22	A		0.3	3.20	0.21	A
2023 Base + Com Dev										
Arm 1						D3	0.7	3.49	0.41	A
Arm 2							0.7	2.92	0.41	A
Arm 3							0.1	3.13	0.10	A
Arm 4							1.7	7.69	0.64	A
Arm 5							0.3	3.38	0.24	A
2023 Base + Com Dev + E3										
Arm 1						D4	0.8	3.89	0.44	A
Arm 2							0.7	3.14	0.43	A
Arm 3							0.2	3.26	0.13	A
Arm 4							2.5	10.12	0.72	B
Arm 5							0.3	3.72	0.26	A

There are warnings associated with one or more model runs - see the 'Data Errors and Warnings' tables for each Analysis or Demand Set.

Values shown are the highest values encountered over all time segments. Delay is the maximum value of average delay per arriving vehicle.

File summary

File Description

Title	
Location	
Site number	
Date	28/01/2022
Version	
Status	(new file)
Identifier	
Client	
Jobnumber	
Enumerator	SLR\long
Description	

Units

Distance units	Speed units	Traffic units input	Traffic units results	Flow units	Average delay units	Total delay units	Rate of delay units
m	kph	Veh	Veh	perHour	s	-Min	perMin

Analysis Options

Vehicle length (m)	Calculate Queue Percentiles	Calculate detailed queueing delay	Calculate residual capacity	RFC Threshold	Average Delay threshold (s)	Queue threshold (PCU)
5.75				0.85	36.00	20.00

Demand Set Summary

ID	Scenario name	Time Period name	Traffic profile type	Start time (HH:mm)	Finish time (HH:mm)	Time segment length (min)	Run automatically
D1	2023 Base	AM	ONE HOUR	07:45	09:15	15	✓
D2	2023 Base	PM	ONE HOUR	16:45	18:15	15	✓
D3	2023 Base + Com Dev	PM	ONE HOUR	16:45	18:15	15	✓
D4	2023 Base + Com Dev + E3	PM	ONE HOUR	16:45	18:15	15	✓

Analysis Set Details

ID	Include in report	Network flow scaling factor (%)	Network capacity scaling factor (%)
A1	✓	100.000	100.000

2023 Base, AM

Data Errors and Warnings

Severity	Area	Item	Description
Warning	Geometry	Arm 1 - Roundabout Geometry	Effective flare length is over 30m, which is outside the normal range. Treat capacities with increasing caution.

Junction Network

Junctions

Junction	Name	Junction type	Use circulating lanes	Arm order	Junction Delay (s)	Junction LOS
1	A14 Claydon Interchange	Large Roundabout		1, 2, 3, 4, 5	5.02	A

Junction Network Options

Driving side	Lighting
Left	Normal/unknown

Arms

Arms

Arm	Name	Description
1	Ipswich Road	
2	A14 Northbound Offslip	
3	Paper Mill Lane	
4	Bramford Road	
5	A14 Southbound Offslip	

Roundabout Geometry

Arm	V - Approach road half-width (m)	E - Entry width (m)	I' - Effective flare length (m)	R - Entry radius (m)	D - Inscribed circle diameter (m)	PHI - Conflict (entry) angle (deg)	Exit only
1	3.05	7.85	36.0	55.3	127.0	15.0	
2	6.32	8.22	20.0	39.5	127.0	34.0	
3	3.05	7.67	24.5	30.4	127.0	18.0	
4	3.60	3.60	0.0	49.9	127.0	10.0	
5	6.90	7.35	20.0	49.7	127.0	14.0	

Large Roundabout Data

Arm	Circulating flow (PCU/hr)	Entry-to-exit separation (m)
1	1032	55.60
2	718	109.60
3	1373	18.00
4	646	55.60
5	1469	107.90

Slope / Intercept / Capacity

Roundabout Slope and Intercept used in model

Arm	Final slope	Final intercept (PCU/hr)
1	0.906	2615
2	1.012	2848
3	0.784	2412
4	0.751	1794
5	0.886	2703

The slope and intercept shown above include any corrections and adjustments.

Traffic Demand

Demand Set Details

ID	Scenario name	Time Period name	Traffic profile type	Start time (HH:mm)	Finish time (HH:mm)	Time segment length (min)	Run automatically
D1	2023 Base	AM	ONE HOUR	07:45	09:15	15	✓

Vehicle mix varies over turn	Vehicle mix varies over entry	Vehicle mix source	PCU Factor for a HV (PCU)
✓	✓	HV Percentages	2.00

Demand overview (Traffic)

Arm	Linked arm	Profile type	Use O-D data	Average Demand (Veh/hr)	Scaling Factor (%)
1		ONE HOUR	✓	838	100.000
2		ONE HOUR	✓	699	100.000
3		ONE HOUR	✓	128	100.000
4		ONE HOUR	✓	777	100.000
5		ONE HOUR	✓	278	100.000

Origin-Destination Data

Demand (Veh/hr)

		To				
		1	2	3	4	5
From	1	0	512	35	201	90
	2	305	0	23	369	2
	3	38	30	0	39	21
	4	233	490	43	11	0
	5	107	2	16	153	0

Vehicle Mix

Heavy Vehicle Percentages

		To				
		1	2	3	4	5
From	1	0	2	0	2	1
	2	3	0	13	13	0
	3	5	10	0	13	10
	4	3	11	0	24	27
	5	3	0	13	13	0

Results

Results Summary for whole modelled period

Arm	Max RFC	Max Delay (s)	Max Queue (Veh)	Max LOS	Average Demand (Veh/hr)	Total Junction Arrivals (Veh)
1	0.52	4.31	1.1	A	769	1153
2	0.38	2.86	0.6	A	641	962
3	0.11	3.26	0.1	A	117	176
4	0.67	8.59	2.0	A	713	1069
5	0.22	3.35	0.3	A	255	383

Main Results for each time segment

07:45 - 08:00

Arm	Total Demand (Veh/hr)	Junction Arrivals (Veh)	Circulating flow (Veh/hr)	Capacity (Veh/hr)	RFC	Throughput (Veh/hr)	Throughput (exit side) (Veh/hr)	Start queue (Veh)	End queue (Veh)	Delay (s)	Unsignalised level of service
1	631	158	558	2017	0.313	629	513	0.0	0.5	2.590	A
2	526	132	412	2218	0.237	525	775	0.0	0.3	2.126	A
3	96	24	849	1550	0.062	96	88	0.0	0.1	2.475	A
4	585	146	365	1396	0.419	582	580	0.0	0.7	4.407	A
5	209	52	862	1731	0.121	209	85	0.0	0.1	2.365	A

08:00 - 08:15

Arm	Total Demand (Veh/hr)	Junction Arrivals (Veh)	Circulating flow (Veh/hr)	Capacity (Veh/hr)	RFC	Throughput (Veh/hr)	Throughput (exit side) (Veh/hr)	Start queue (Veh)	End queue (Veh)	Delay (s)	Unsignalised level of service
1	753	188	669	1908	0.395	753	613	0.5	0.6	3.113	A
2	628	157	493	2138	0.294	628	928	0.3	0.4	2.383	A
3	115	29	1016	1422	0.081	115	105	0.1	0.1	2.754	A
4	699	175	437	1345	0.519	697	694	0.7	1.1	5.545	A
5	250	62	1032	1583	0.158	250	101	0.1	0.2	2.699	A

08:15 - 08:30

Arm	Total Demand (Veh/hr)	Junction Arrivals (Veh)	Circulating flow (Veh/hr)	Capacity (Veh/hr)	RFC	Throughput (Veh/hr)	Throughput (exit side) (Veh/hr)	Start queue (Veh)	End queue (Veh)	Delay (s)	Unsignalised level of service
1	923	231	817	1761	0.524	921	750	0.6	1.1	4.274	A
2	770	192	603	2030	0.379	769	1135	0.4	0.6	2.853	A
3	141	35	1244	1246	0.113	141	128	0.1	0.1	3.255	A
4	855	214	534	1274	0.671	852	850	1.1	2.0	8.445	A
5	306	77	1262	1384	0.221	306	124	0.2	0.3	3.338	A

08:30 - 08:45

Arm	Total Demand (Veh/hr)	Junction Arrivals (Veh)	Circulating flow (Veh/hr)	Capacity (Veh/hr)	RFC	Throughput (Veh/hr)	Throughput (exit side) (Veh/hr)	Start queue (Veh)	End queue (Veh)	Delay (s)	Unsignalised level of service
1	923	231	820	1759	0.525	923	752	1.1	1.1	4.305	A
2	770	192	604	2029	0.379	770	1138	0.6	0.6	2.857	A
3	141	35	1245	1245	0.113	141	129	0.1	0.1	3.259	A
4	855	214	535	1274	0.672	855	851	2.0	2.0	8.593	A
5	306	77	1266	1381	0.222	306	124	0.3	0.3	3.349	A

08:45 - 09:00

Arm	Total Demand (Veh/hr)	Junction Arrivals (Veh)	Circulating flow (Veh/hr)	Capacity (Veh/hr)	RFC	Throughput (Veh/hr)	Throughput (exit side) (Veh/hr)	Start queue (Veh)	End queue (Veh)	Delay (s)	Unsignalised level of service
1	753	188	673	1904	0.396	755	616	1.1	0.7	3.136	A
2	628	157	495	2137	0.294	629	933	0.6	0.4	2.390	A
3	115	29	1018	1420	0.081	115	106	0.1	0.1	2.758	A
4	699	175	438	1344	0.520	702	696	2.0	1.1	5.639	A
5	250	62	1038	1578	0.158	250	102	0.3	0.2	2.710	A

09:00 - 09:15

Arm	Total Demand (Veh/hr)	Junction Arrivals (Veh)	Circulating flow (Veh/hr)	Capacity (Veh/hr)	RFC	Throughput (Veh/hr)	Throughput (exit side) (Veh/hr)	Start queue (Veh)	End queue (Veh)	Delay (s)	Unsignalised level of service
1	631	158	562	2014	0.313	632	515	0.7	0.5	2.608	A
2	526	132	414	2216	0.237	527	780	0.4	0.3	2.131	A
3	96	24	852	1548	0.062	96	88	0.1	0.1	2.479	A
4	585	146	366	1395	0.419	586	583	1.1	0.7	4.459	A
5	209	52	867	1726	0.121	209	85	0.2	0.1	2.373	A

2023 Base, PM

Data Errors and Warnings

Severity	Area	Item	Description
Warning	Geometry	Arm 1 - Roundabout Geometry	Effective flare length is over 30m, which is outside the normal range. Treat capacities with increasing caution.

Junction Network

Junctions

Junction	Name	Junction type	Use circulating lanes	Arm order	Junction Delay (s)	Junction LOS
1	A14 Claydon Interchange	Large Roundabout		1, 2, 3, 4, 5	4.31	A

Junction Network Options

Driving side	Lighting
Left	Normal/unknown

Arms

Arms

[same as above]

Roundabout Geometry

[same as above]

Large Roundabout Data

Arm	Circulating flow (PCU/hr)	Entry-to-exit separation (m)
1	1032	55.60
2	718	109.60
3	1373	18.00
4	646	55.60
5	1469	107.90

Slope / Intercept / Capacity

[same as above]

Traffic Demand

Demand Set Details

ID	Scenario name	Time Period name	Traffic profile type	Start time (HH:mm)	Finish time (HH:mm)	Time segment length (min)	Run automatically
D2	2023 Base	PM	ONE HOUR	16:45	18:15	15	✓

Vehicle mix varies over turn	Vehicle mix varies over entry	Vehicle mix source	PCU Factor for a HV (PCU)
✓	✓	HV Percentages	2.00

Demand overview (Traffic)

Arm	Linked arm	Profile type	Use O-D data	Average Demand (Veh/hr)	Scaling Factor (%)
1		ONE HOUR	✓	646	100.000
2		ONE HOUR	✓	722	100.000
3		ONE HOUR	✓	112	100.000
4		ONE HOUR	✓	736	100.000
5		ONE HOUR	✓	274	100.000

Origin-Destination Data

Demand (Veh/hr)

		To				
		1	2	3	4	5
From	1	0	343	32	200	71
	2	355	0	35	330	2
	3	29	36	0	24	23
	4	204	480	48	4	0
	5	104	3	26	141	0

Vehicle Mix

Heavy Vehicle Percentages

		To				
		1	2	3	4	5
From	1	0	2	3	3	1
	2	3	0	15	9	0
	3	0	6	0	17	0
	4	2	5	2	75	6
	5	3	0	0	12	0

Results

Results Summary for whole modelled period

Arm	Max RFC	Max Delay (s)	Max Queue (Veh)	Max LOS	Average Demand (Veh/hr)	Total Junction Arrivals (Veh)
1	0.40	3.33	0.7	A	593	889
2	0.38	2.75	0.6	A	663	994
3	0.09	2.99	0.1	A	103	154
4	0.62	7.35	1.6	A	675	1013
5	0.21	3.20	0.3	A	251	377

Main Results for each time segment

16:45 - 17:00

Arm	Total Demand (Veh/hr)	Junction Arrivals (Veh)	Circulating flow (Veh/hr)	Capacity (Veh/hr)	RFC	Throughput (Veh/hr)	Throughput (exit side) (Veh/hr)	Start queue (Veh)	End queue (Veh)	Delay (s)	Unsignalised level of service
1	486	122	553	2036	0.239	485	519	0.0	0.3	2.319	A
2	544	136	392	2285	0.238	542	647	0.0	0.3	2.064	A
3	84	21	828	1632	0.052	84	106	0.0	0.1	2.325	A
4	554	139	388	1433	0.387	552	525	0.0	0.6	4.072	A
5	206	52	867	1775	0.116	206	72	0.0	0.1	2.294	A

17:00 - 17:15

Arm	Total Demand (Veh/hr)	Junction Arrivals (Veh)	Circulating flow (Veh/hr)	Capacity (Veh/hr)	RFC	Throughput (Veh/hr)	Throughput (exit side) (Veh/hr)	Start queue (Veh)	End queue (Veh)	Delay (s)	Unsignalised level of service
1	581	145	662	1933	0.300	580	621	0.3	0.4	2.661	A
2	649	162	469	2208	0.294	649	774	0.3	0.4	2.308	A
3	101	25	991	1504	0.067	101	127	0.1	0.1	2.564	A
4	662	165	464	1377	0.481	660	628	0.6	0.9	5.016	A
5	246	62	1038	1629	0.151	246	86	0.1	0.2	2.603	A

17:15 - 17:30

Arm	Total Demand (Veh/hr)	Junction Arrivals (Veh)	Circulating flow (Veh/hr)	Capacity (Veh/hr)	RFC	Throughput (Veh/hr)	Throughput (exit side) (Veh/hr)	Start queue (Veh)	End queue (Veh)	Delay (s)	Unsignalised level of service
1	711	178	810	1794	0.397	710	761	0.4	0.7	3.319	A
2	795	199	574	2103	0.378	794	947	0.4	0.6	2.750	A
3	123	31	1213	1329	0.093	123	155	0.1	0.1	2.985	A
4	810	203	568	1300	0.623	808	769	0.9	1.6	7.267	A
5	302	75	1270	1430	0.211	301	106	0.2	0.3	3.189	A

17:30 - 17:45

Arm	Total Demand (Veh/hr)	Junction Arrivals (Veh)	Circulating flow (Veh/hr)	Capacity (Veh/hr)	RFC	Throughput (Veh/hr)	Throughput (exit side) (Veh/hr)	Start queue (Veh)	End queue (Veh)	Delay (s)	Unsignalised level of service
1	711	178	812	1792	0.397	711	762	0.7	0.7	3.331	A
2	795	199	575	2102	0.378	795	949	0.6	0.6	2.753	A
3	123	31	1214	1328	0.093	123	155	0.1	0.1	2.987	A
4	810	203	568	1300	0.624	810	770	1.6	1.6	7.353	A
5	302	75	1273	1427	0.211	302	106	0.3	0.3	3.197	A

17:45 - 18:00

Arm	Total Demand (Veh/hr)	Junction Arrivals (Veh)	Circulating flow (Veh/hr)	Capacity (Veh/hr)	RFC	Throughput (Veh/hr)	Throughput (exit side) (Veh/hr)	Start queue (Veh)	End queue (Veh)	Delay (s)	Unsignalised level of service
1	581	145	666	1930	0.301	582	623	0.7	0.4	2.673	A
2	649	162	470	2207	0.294	650	777	0.6	0.4	2.312	A
3	101	25	993	1503	0.067	101	127	0.1	0.1	2.569	A
4	662	165	464	1376	0.481	664	629	1.6	0.9	5.076	A
5	246	62	1042	1625	0.152	247	86	0.3	0.2	2.612	A

18:00 - 18:15

Arm	Total Demand (Veh/hr)	Junction Arrivals (Veh)	Circulating flow (Veh/hr)	Capacity (Veh/hr)	RFC	Throughput (Veh/hr)	Throughput (exit side) (Veh/hr)	Start queue (Veh)	End queue (Veh)	Delay (s)	Unsignalised level of service
1	486	122	557	2033	0.239	487	522	0.4	0.3	2.330	A
2	544	136	393	2284	0.238	544	650	0.4	0.3	2.069	A
3	84	21	831	1630	0.052	84	106	0.1	0.1	2.328	A
4	554	139	389	1432	0.387	555	527	0.9	0.6	4.112	A
5	206	52	872	1771	0.116	206	72	0.2	0.1	2.300	A

2023 Base + Com Dev, PM

Data Errors and Warnings

Severity	Area	Item	Description
Warning	Geometry	Arm 1 - Roundabout Geometry	Effective flare length is over 30m, which is outside the normal range. Treat capacities with increasing caution.

Junction Network

Junctions

Junction	Name	Junction type	Use circulating lanes	Arm order	Junction Delay (s)	Junction LOS
1	A14 Claydon Interchange	Large Roundabout		1, 2, 3, 4, 5	4.50	A

Junction Network Options

Driving side	Lighting
Left	Normal/unknown

Arms

Arms

[same as above]

Roundabout Geometry

[same as above]

Large Roundabout Data

Arm	Circulating flow (PCU/hr)	Entry-to-exit separation (m)
1	1032	55.60
2	718	109.60
3	1373	18.00
4	646	55.60
5	1469	107.90

Slope / Intercept / Capacity

[same as above]

Traffic Demand

Demand Set Details

ID	Scenario name	Time Period name	Traffic profile type	Start time (HH:mm)	Finish time (HH:mm)	Time segment length (min)	Run automatically
D3	2023 Base + Com Dev	PM	ONE HOUR	16:45	18:15	15	✓

Vehicle mix varies over turn	Vehicle mix varies over entry	Vehicle mix source	PCU Factor for a HV (PCU)
✓	✓	HV Percentages	2.00

Demand overview (Traffic)

Arm	Linked arm	Profile type	Use O-D data	Average Demand (Veh/hr)	Scaling Factor (%)
1		ONE HOUR	✓	652	100.000
2		ONE HOUR	✓	764	100.000
3		ONE HOUR	✓	112	100.000
4		ONE HOUR	✓	749	100.000
5		ONE HOUR	✓	302	100.000

Origin-Destination Data

Demand (Veh/hr)

		To				
		1	2	3	4	5
From	1	0	349	32	200	71
	2	369	0	35	358	2
	3	29	36	0	24	23
	4	204	497	48	0	0
	5	104	3	26	169	0

Vehicle Mix

Heavy Vehicle Percentages

		To				
		1	2	3	4	5
From	1	0	2	3	3	1
	2	3	0	15	9	0
	3	0	6	0	17	0
	4	2	5	2	75	6
	5	3	0	0	12	0

Results

Results Summary for whole modelled period

Arm	Max RFC	Max Delay (s)	Max Queue (Veh)	Max LOS	Average Demand (Veh/hr)	Total Junction Arrivals (Veh)
1	0.41	3.49	0.7	A	598	897
2	0.41	2.92	0.7	A	701	1052
3	0.10	3.13	0.1	A	103	154
4	0.64	7.69	1.7	A	687	1031
5	0.24	3.38	0.3	A	277	416

Main Results for each time segment

16:45 - 17:00

Arm	Total Demand (Veh/hr)	Junction Arrivals (Veh)	Circulating flow (Veh/hr)	Capacity (Veh/hr)	RFC	Throughput (Veh/hr)	Throughput (exit side) (Veh/hr)	Start queue (Veh)	End queue (Veh)	Delay (s)	Unsignalised level of service
1	491	123	584	2008	0.244	490	530	0.0	0.3	2.368	A
2	575	144	410	2267	0.254	574	664	0.0	0.3	2.124	A
3	84	21	878	1594	0.053	84	106	0.0	0.1	2.384	A
4	564	141	398	1430	0.394	561	564	0.0	0.6	4.130	A
5	227	57	887	1752	0.130	227	72	0.0	0.1	2.360	A

17:00 - 17:15

Arm	Total Demand (Veh/hr)	Junction Arrivals (Veh)	Circulating flow (Veh/hr)	Capacity (Veh/hr)	RFC	Throughput (Veh/hr)	Throughput (exit side) (Veh/hr)	Start queue (Veh)	End queue (Veh)	Delay (s)	Unsignalised level of service
1	586	147	699	1900	0.309	586	634	0.3	0.4	2.740	A
2	687	172	490	2187	0.314	686	794	0.3	0.5	2.400	A
3	101	25	1050	1458	0.069	101	127	0.1	0.1	2.651	A
4	673	168	476	1372	0.491	672	675	0.6	1.0	5.131	A
5	271	68	1062	1604	0.169	271	86	0.1	0.2	2.702	A

17:15 - 17:30

Arm	Total Demand (Veh/hr)	Junction Arrivals (Veh)	Circulating flow (Veh/hr)	Capacity (Veh/hr)	RFC	Throughput (Veh/hr)	Throughput (exit side) (Veh/hr)	Start queue (Veh)	End queue (Veh)	Delay (s)	Unsignalised level of service
1	718	179	855	1753	0.410	717	776	0.4	0.7	3.472	A
2	841	210	600	2077	0.405	840	972	0.5	0.7	2.911	A
3	123	31	1286	1272	0.097	123	155	0.1	0.1	3.131	A
4	825	206	583	1293	0.638	822	826	1.0	1.7	7.584	A
5	333	83	1299	1402	0.237	332	106	0.2	0.3	3.363	A

17:30 - 17:45

Arm	Total Demand (Veh/hr)	Junction Arrivals (Veh)	Circulating flow (Veh/hr)	Capacity (Veh/hr)	RFC	Throughput (Veh/hr)	Throughput (exit side) (Veh/hr)	Start queue (Veh)	End queue (Veh)	Delay (s)	Unsignalised level of service
1	718	179	858	1750	0.410	718	777	0.7	0.7	3.485	A
2	841	210	601	2076	0.405	841	974	0.7	0.7	2.915	A
3	123	31	1287	1271	0.097	123	155	0.1	0.1	3.135	A
4	825	206	584	1293	0.638	825	827	1.7	1.7	7.686	A
5	333	83	1302	1399	0.238	333	106	0.3	0.3	3.375	A

17:45 - 18:00

Arm	Total Demand (Veh/hr)	Junction Arrivals (Veh)	Circulating flow (Veh/hr)	Capacity (Veh/hr)	RFC	Throughput (Veh/hr)	Throughput (exit side) (Veh/hr)	Start queue (Veh)	End queue (Veh)	Delay (s)	Unsignalised level of service
1	586	147	703	1896	0.309	587	636	0.7	0.4	2.751	A
2	687	172	492	2185	0.314	688	798	0.7	0.5	2.405	A
3	101	25	1052	1456	0.069	101	127	0.1	0.1	2.657	A
4	673	168	477	1372	0.491	676	676	1.7	1.0	5.200	A
5	271	68	1067	1599	0.170	272	86	0.3	0.2	2.712	A

18:00 - 18:15

Arm	Total Demand (Veh/hr)	Junction Arrivals (Veh)	Circulating flow (Veh/hr)	Capacity (Veh/hr)	RFC	Throughput (Veh/hr)	Throughput (exit side) (Veh/hr)	Start queue (Veh)	End queue (Veh)	Delay (s)	Unsignalised level of service
1	491	123	588	2005	0.245	491	532	0.4	0.3	2.381	A
2	575	144	412	2266	0.254	576	667	0.5	0.3	2.132	A
3	84	21	881	1591	0.053	84	106	0.1	0.1	2.388	A
4	564	141	399	1429	0.395	565	566	1.0	0.7	4.173	A
5	227	57	892	1748	0.130	228	72	0.2	0.1	2.369	A

2023 Base + Com Dev + E3, PM

Data Errors and Warnings

Severity	Area	Item	Description
Warning	Geometry	Arm 1 - Roundabout Geometry	Effective flare length is over 30m, which is outside the normal range. Treat capacities with increasing caution.

Junction Network

Junctions

Junction	Name	Junction type	Use circulating lanes	Arm order	Junction Delay (s)	Junction LOS
1	A14 Claydon Interchange	Large Roundabout		1, 2, 3, 4, 5	5.50	A

Junction Network Options

Driving side	Lighting
Left	Normal/unknown

Arms

Arms

[same as above]

Roundabout Geometry

[same as above]

Large Roundabout Data

Arm	Circulating flow (PCU/hr)	Entry-to-exit separation (m)
1	1032	55.60
2	718	109.60
3	1373	18.00
4	646	55.60
5	1469	107.90

Slope / Intercept / Capacity

[same as above]

Traffic Demand

Demand Set Details

ID	Scenario name	Time Period name	Traffic profile type	Start time (HH:mm)	Finish time (HH:mm)	Time segment length (min)	Run automatically
D4	2023 Base + Com Dev + E3	PM	ONE HOUR	16:45	18:15	15	✓

Vehicle mix varies over turn	Vehicle mix varies over entry	Vehicle mix source	PCU Factor for a HV (PCU)
✓	✓	HV Percentages	2.00

Demand overview (Traffic)

Arm	Linked arm	Profile type	Use O-D data	Average Demand (Veh/hr)	Scaling Factor (%)
1		ONE HOUR	✓	652	100.000
2		ONE HOUR	✓	771	100.000
3		ONE HOUR	✓	153	100.000
4		ONE HOUR	✓	823	100.000
5		ONE HOUR	✓	304	100.000

Origin-Destination Data

Demand (Veh/hr)

		To				
		1	2	3	4	5
From	1	0	349	32	200	71
	2	369	0	36	364	2
	3	29	68	0	24	32
	4	204	497	122	0	0
	5	104	3	27	170	0

Vehicle Mix

Heavy Vehicle Percentages

		To				
		1	2	3	4	5
From	1	0	2	3	3	1
	2	3	0	15	9	0
	3	0	4	0	17	3
	4	2	5	2	75	6
	5	3	0	0	12	0

Results

Results Summary for whole modelled period

Arm	Max RFC	Max Delay (s)	Max Queue (Veh)	Max LOS	Average Demand (Veh/hr)	Total Junction Arrivals (Veh)
1	0.44	3.89	0.8	A	598	897
2	0.43	3.14	0.7	A	707	1061
3	0.13	3.26	0.2	A	140	211
4	0.72	10.12	2.5	B	755	1133
5	0.26	3.72	0.3	A	279	418

Main Results for each time segment

16:45 - 17:00

Arm	Total Demand (Veh/hr)	Junction Arrivals (Veh)	Circulating flow (Veh/hr)	Capacity (Veh/hr)	RFC	Throughput (Veh/hr)	Throughput (exit side) (Veh/hr)	Start queue (Veh)	End queue (Veh)	Delay (s)	Unsignalised level of service
1	491	123	665	1935	0.254	490	530	0.0	0.3	2.488	A
2	580	145	467	2211	0.263	579	688	0.0	0.4	2.203	A
3	115	29	883	1597	0.072	115	163	0.0	0.1	2.429	A
4	620	155	429	1410	0.440	616	569	0.0	0.8	4.522	A
5	229	57	966	1686	0.136	228	79	0.0	0.2	2.467	A

17:00 - 17:15

Arm	Total Demand (Veh/hr)	Junction Arrivals (Veh)	Circulating flow (Veh/hr)	Capacity (Veh/hr)	RFC	Throughput (Veh/hr)	Throughput (exit side) (Veh/hr)	Start queue (Veh)	End queue (Veh)	Delay (s)	Unsignalised level of service
1	586	147	796	1812	0.323	586	634	0.3	0.5	2.933	A
2	693	173	559	2120	0.327	693	823	0.4	0.5	2.522	A
3	138	34	1056	1460	0.094	137	195	0.1	0.1	2.722	A
4	740	185	513	1347	0.549	738	681	0.8	1.2	5.895	A
5	273	68	1157	1524	0.179	273	94	0.2	0.2	2.877	A

17:15 - 17:30

Arm	Total Demand (Veh/hr)	Junction Arrivals (Veh)	Circulating flow (Veh/hr)	Capacity (Veh/hr)	RFC	Throughput (Veh/hr)	Throughput (exit side) (Veh/hr)	Start queue (Veh)	End queue (Veh)	Delay (s)	Unsignalised level of service
1	718	179	972	1647	0.436	717	775	0.5	0.8	3.866	A
2	849	212	683	1995	0.425	848	1006	0.5	0.7	3.134	A
3	168	42	1293	1272	0.132	168	238	0.1	0.2	3.260	A
4	906	227	628	1262	0.718	901	833	1.2	2.5	9.849	A
5	335	84	1414	1306	0.256	334	115	0.2	0.3	3.703	A

17:30 - 17:45

Arm	Total Demand (Veh/hr)	Junction Arrivals (Veh)	Circulating flow (Veh/hr)	Capacity (Veh/hr)	RFC	Throughput (Veh/hr)	Throughput (exit side) (Veh/hr)	Start queue (Veh)	End queue (Veh)	Delay (s)	Unsignalised level of service
1	718	179	976	1643	0.437	718	777	0.8	0.8	3.891	A
2	849	212	685	1994	0.426	849	1010	0.7	0.7	3.143	A
3	168	42	1295	1271	0.133	168	239	0.2	0.2	3.264	A
4	906	227	629	1261	0.719	906	835	2.5	2.5	10.123	B
5	335	84	1419	1301	0.257	335	116	0.3	0.3	3.723	A

17:45 - 18:00

Arm	Total Demand (Veh/hr)	Junction Arrivals (Veh)	Circulating flow (Veh/hr)	Capacity (Veh/hr)	RFC	Throughput (Veh/hr)	Throughput (exit side) (Veh/hr)	Start queue (Veh)	End queue (Veh)	Delay (s)	Unsignalised level of service
1	586	147	802	1807	0.324	587	637	0.8	0.5	2.956	A
2	693	173	561	2118	0.327	694	828	0.7	0.5	2.532	A
3	138	34	1059	1458	0.094	138	196	0.2	0.1	2.727	A
4	740	185	514	1346	0.550	745	683	2.5	1.2	6.037	A
5	273	68	1164	1518	0.180	274	95	0.3	0.2	2.896	A

18:00 - 18:15

Arm	Total Demand (Veh/hr)	Junction Arrivals (Veh)	Circulating flow (Veh/hr)	Capacity (Veh/hr)	RFC	Throughput (Veh/hr)	Throughput (exit side) (Veh/hr)	Start queue (Veh)	End queue (Veh)	Delay (s)	Unsignalised level of service
1	491	123	669	1931	0.254	491	532	0.5	0.3	2.503	A
2	580	145	469	2209	0.263	581	692	0.5	0.4	2.213	A
3	115	29	886	1594	0.072	115	164	0.1	0.1	2.435	A
4	620	155	430	1409	0.440	621	571	1.2	0.8	4.583	A
5	229	57	973	1681	0.136	229	79	0.2	0.2	2.479	A

APPENDIX 04

Crashmap Screenshots

2011 - 2015

Claydon Interchange

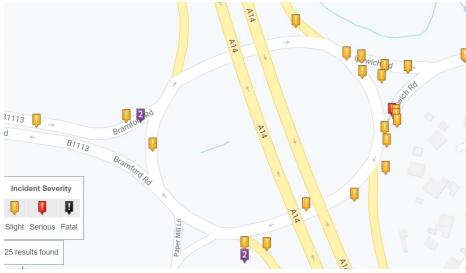

2016 -2020

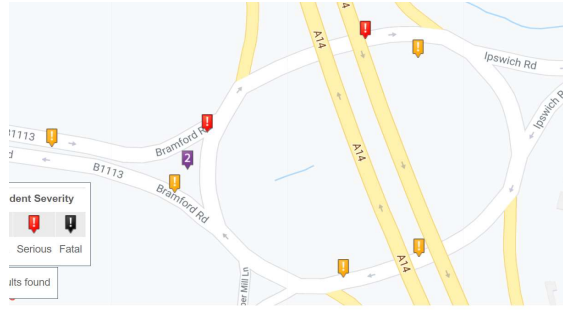

B1113 / Somersham Road

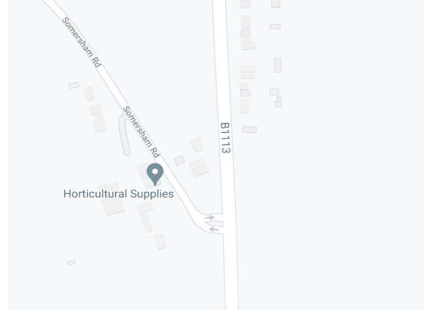
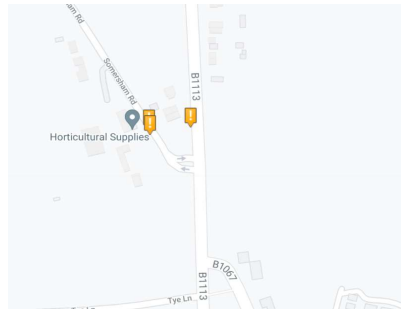

B1113 / Bullen Lane

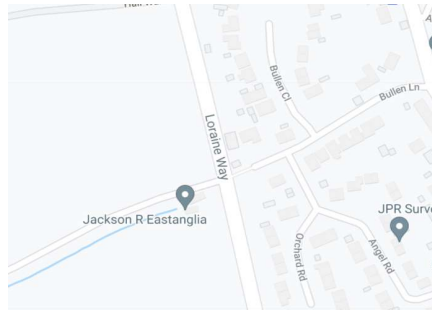

B1113 / A1071

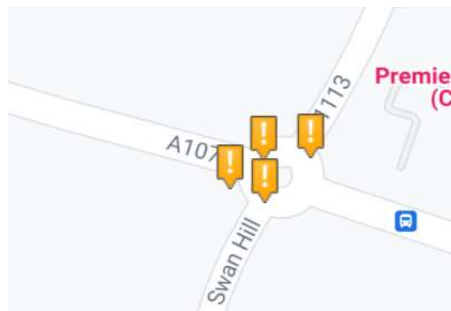
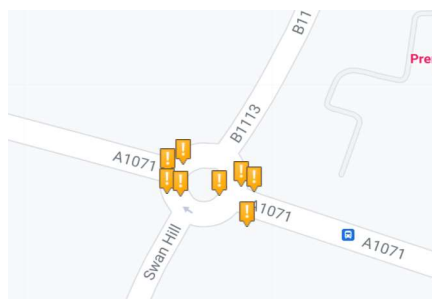

Paper Mill Lane

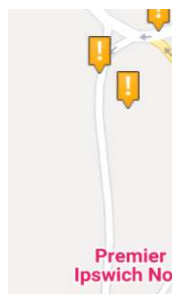
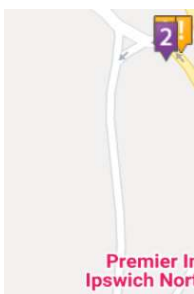

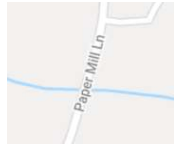
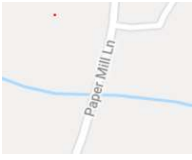

APPENDIX 05

Crashmap Reports



Validated Data

Crash Date:	Wednesday, November 09, 2016	Time of Crash:	10:43:00 PM	Crash Reference:	2016370132278
Highest Injury Severity:	Slight	Road Number:	U0	Number of Casualties:	1
Highway Authority:	Suffolk			Number of Vehicles:	1
Local Authority:	Mid Suffolk District			OS Grid Reference:	612880 249408
Weather Description:	Fine without high winds				
Road Surface Description:	Wet or Damp				
Speed Limit:	70				
Light Conditions:	Darkness: street lights present and lit				
Carriageway Hazards:	None				
Junction Detail:	Not at or within 20 metres of junction				
Junction Pedestrian Crossing:	No physical crossing facility within 50 metres				
Road Type:	Dual carriageway				
Junction Control:	Not Applicable				

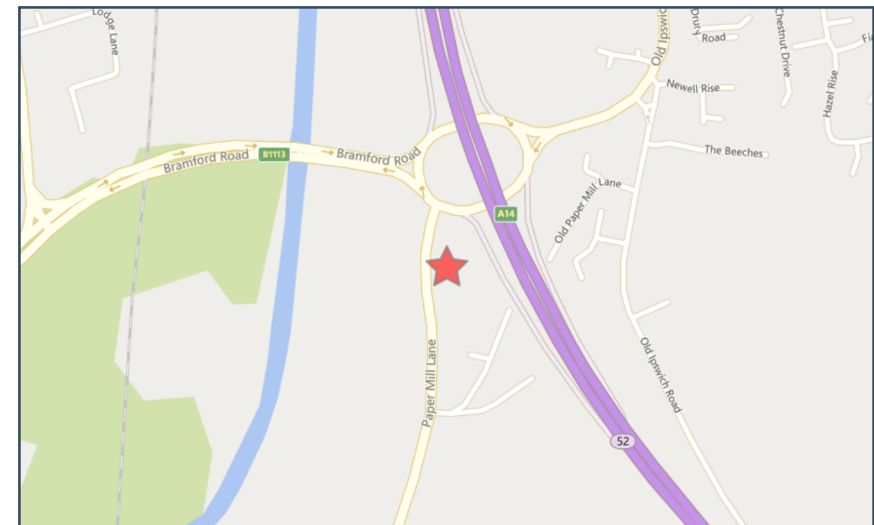

For more information about the data please visit: www.crashmap.co.uk/home/Faq
To subscribe to unlimited reports using CrashMap Pro visit www.crashmap.co.uk/Home/Premium_Services



Validated Data

Vehicles involved

Vehicle Ref	Vehicle Type	Vehicle Age	Driver Gender	Driver Age Band	Vehicle Maneouvre	First Point of Impact	Journey Purpose	Hit Object - On Carriageway	Hit Object - Off Carriageway
1	Car (excluding private hire)	15	Male	46 - 55	Vehicle proceeding normally along the carriageway, not on a bend	Front	Other	None	None

Casualties

Vehicle Ref	Casualty Ref	Injury Severity	Casualty Class	Gender	Age Band	Pedestrian Location	Pedestrian Movement
1	1	Slight	Vehicle or pillion passenger	Female	36 - 45	Unknown or other	Unknown or other

For more information about the data please visit: www.crashmap.co.uk/home/Faq

To subscribe to unlimited reports using CrashMap Pro visit www.crashmap.co.uk/Home/Premium_Services



Validated Data

Crash Date: Monday, August 21, 2017 **Time of Crash:** 5:50:00 PM **Crash Reference:** 2017370218598

Highest Injury Severity:	Slight	Road Number:	B1113	Number of Casualties:	1
Highway Authority:	Suffolk			Number of Vehicles:	4
Local Authority:	Mid Suffolk District			OS Grid Reference:	612819 249547
Weather Description:	Fine without high winds				
Road Surface Description:	Dry				
Speed Limit:	40				
Light Conditions:	Daylight: regardless of presence of streetlights				
Carriageway Hazards:	None				
Junction Detail:	Not at or within 20 metres of junction				
Junction Pedestrian Crossing:	No physical crossing facility within 50 metres				
Road Type:	Single carriageway				
Junction Control:	Not Applicable				

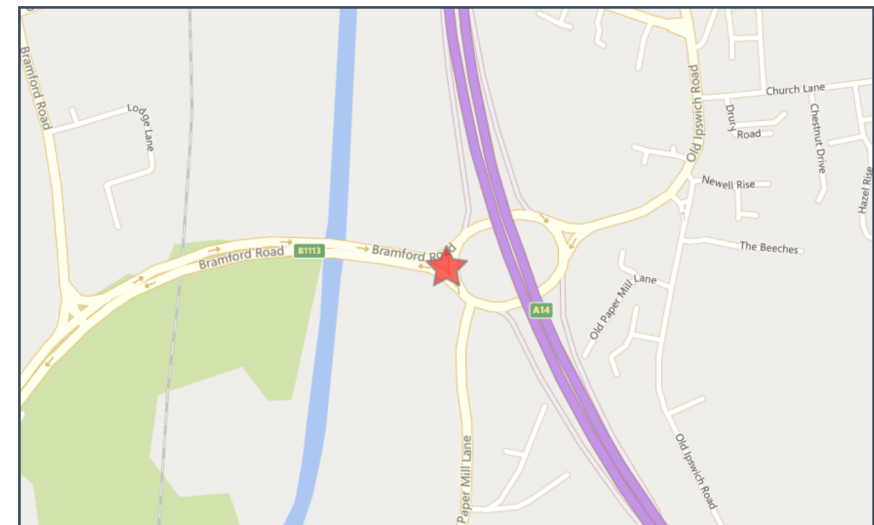

For more information about the data please visit: www.crashmap.co.uk/home/Faq
To subscribe to unlimited reports using CrashMap Pro visit www.crashmap.co.uk/Home/Premium_Services



Validated Data

Vehicles involved

Vehicle Ref	Vehicle Type	Vehicle Age	Driver Gender	Driver Age Band	Vehicle Maneouvre	First Point of Impact	Journey Purpose	Hit Object - On Carriageway	Hit Object - Off Carriageway
1	Van or goods vehicle 3.5 tonnes mgw and under	10	Male	26 - 35	Vehicle proceeding normally along the carriageway, not on a bend	Front	Other	None	None
2	Car (excluding private hire)	18	Male	16 - 20	Vehicle is slowing down or stopping	Front	Other	None	None
3	Car (excluding private hire)	12	Male	56 - 65	Vehicle is slowing down or stopping	Back	Other	None	None
4	Car (excluding private hire)	9	Female	26 - 35	Vehicle is slowing down or stopping	Back	Commuting to/from work	None	None

Casualties

Vehicle Ref	Casualty Ref	Injury Severity	Casualty Class	Gender	Age Band	Pedestrian Location	Pedestrian Movement
1	1	Slight	Driver or rider	Male	26 - 35	Unknown or other	Unknown or other

For more information about the data please visit: www.crashmap.co.uk/home/Faq

To subscribe to unlimited reports using CrashMap Pro visit www.crashmap.co.uk/Home/Premium_Services



Validated Data

Crash Date: Friday, July 20, 2018 **Time of Crash:** 7:26:00 AM **Crash Reference:** 2018370319130

Highest Injury Severity:	Slight	Road Number:	B1113	Number of Casualties:	1
Highway Authority:	Suffolk			Number of Vehicles:	2
Local Authority:	Mid Suffolk District			OS Grid Reference:	612819 249547
Weather Description:	Fine without high winds				
Road Surface Description:	Dry				
Speed Limit:	30				
Light Conditions:	Daylight: regardless of presence of streetlights				
Carriageway Hazards:	None				
Junction Detail:	Other junction				
Junction Pedestrian Crossing:	No physical crossing facility within 50 metres				
Road Type:	Single carriageway				
Junction Control:	Give way or uncontrolled				

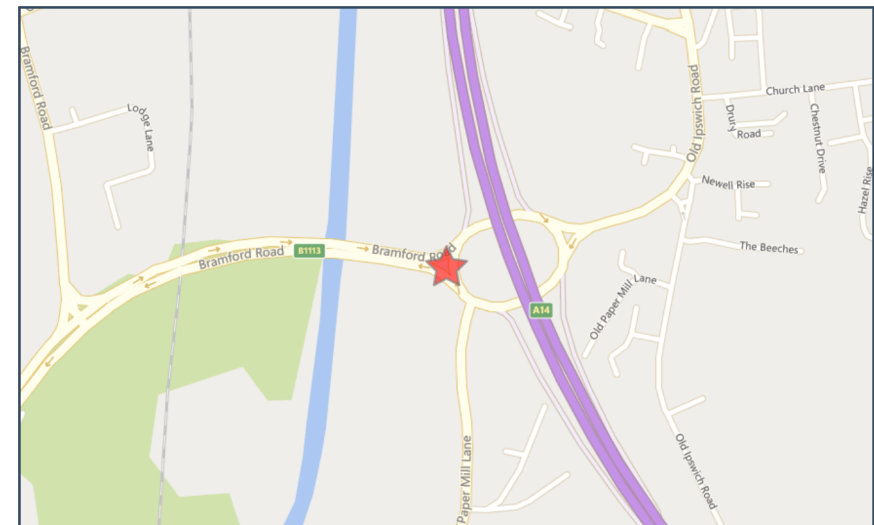

For more information about the data please visit: www.crashmap.co.uk/home/Faq
To subscribe to unlimited reports using CrashMap Pro visit www.crashmap.co.uk/Home/Premium_Services



Validated Data

Vehicles involved

Vehicle Ref	Vehicle Type	Vehicle Age	Driver Gender	Driver Age Band	Vehicle Maneouvre	First Point of Impact	Journey Purpose	Hit Object - On Carriageway	Hit Object - Off Carriageway
1	Car (excluding private hire)		2 Male	46 - 55	Vehicle proceeding normally along the carriageway, not on a bend	Front	Journey as part of work	None	Wall or fence
2	Agricultural vehicle		4 Male	26 - 35	Vehicle proceeding normally along the carriageway, not on a bend	Offside	Journey as part of work	None	None

Casualties

Vehicle Ref	Casualty Ref	Injury Severity	Casualty Class	Gender	Age Band	Pedestrian Location	Pedestrian Movement
1	1	Slight	Driver or rider	Male	46 - 55	Unknown or other	Unknown or other

For more information about the data please visit: www.crashmap.co.uk/home/Faq

To subscribe to unlimited reports using CrashMap Pro visit www.crashmap.co.uk/Home/Premium_Services



Validated Data

Crash Date: Thursday, July 19, 2018 **Time of Crash:** 5:45:00 AM **Crash Reference:** 2018370336188

Highest Injury Severity:	Serious	Road Number:	B1113	Number of Casualties:	1
Highway Authority:	Suffolk	Number of Vehicles:	1	OS Grid Reference:	612829 249569
Local Authority:	Mid Suffolk District				
Weather Description:	Fine without high winds				
Road Surface Description:	Dry				
Speed Limit:	70				
Light Conditions:	Daylight: regardless of presence of streetlights				
Carriageway Hazards:	None				
Junction Detail:	Roundabout				
Junction Pedestrian Crossing:	No physical crossing facility within 50 metres				
Road Type:	Dual carriageway				
Junction Control:	Give way or uncontrolled				

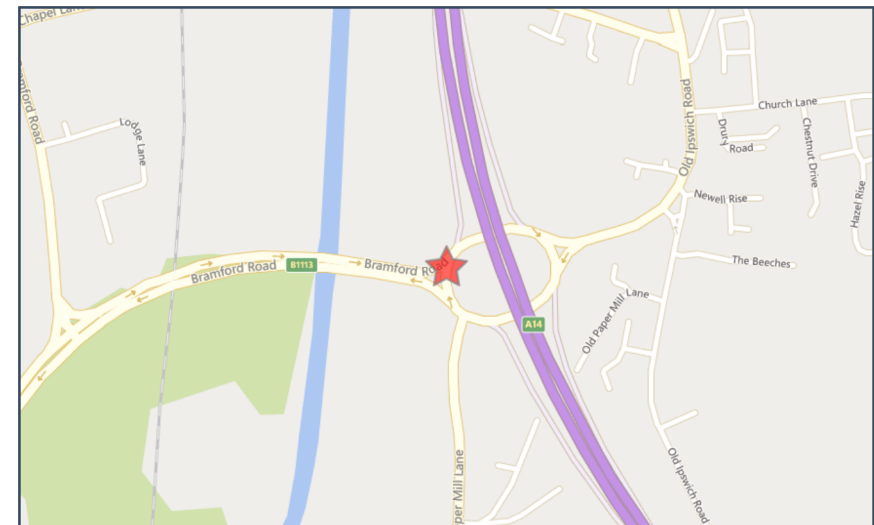

For more information about the data please visit: www.crashmap.co.uk/home/Faq
To subscribe to unlimited reports using CrashMap Pro visit www.crashmap.co.uk/Home/Premium_Services



Validated Data

Vehicles involved

Vehicle Ref	Vehicle Type	Vehicle Age	Driver Gender	Driver Age Band	Vehicle Manoeuvre	First Point of Impact	Journey Purpose	Hit Object - On Carriageway	Hit Object - Off Carriageway
1	Motorcycle over 50cc and up to 125cc	11	Male	36 - 45	Vehicle proceeding normally along the carriageway, not on a bend	Nearside	Commuting to/from work	None	None

Casualties

Vehicle Ref	Casualty Ref	Injury Severity	Casualty Class	Gender	Age Band	Pedestrian Location	Pedestrian Movement
1	1	Serious	Driver or rider	Male	36 - 45	Unknown or other	Unknown or other

For more information about the data please visit: www.crashmap.co.uk/home/Faq

To subscribe to unlimited reports using CrashMap Pro visit www.crashmap.co.uk/Home/Premium_Services



Validated Data

Crash Date: Friday, October 05, 2018 **Time of Crash:** 8:27:00 AM **Crash Reference:** 2018370338860

Highest Injury Severity:	Slight	Road Number:	U0	Number of Casualties:	2
Highway Authority:	Suffolk	Number of Vehicles:	2	OS Grid Reference:	612846 249443
Local Authority:	Mid Suffolk District				
Weather Description:	Fine without high winds				
Road Surface Description:	Wet or Damp				
Speed Limit:	60				
Light Conditions:	Daylight: regardless of presence of streetlights				
Carriageway Hazards:	None				
Junction Detail:	Roundabout				
Junction Pedestrian Crossing:	No physical crossing facility within 50 metres				
Road Type:	Single carriageway				
Junction Control:	Give way or uncontrolled				

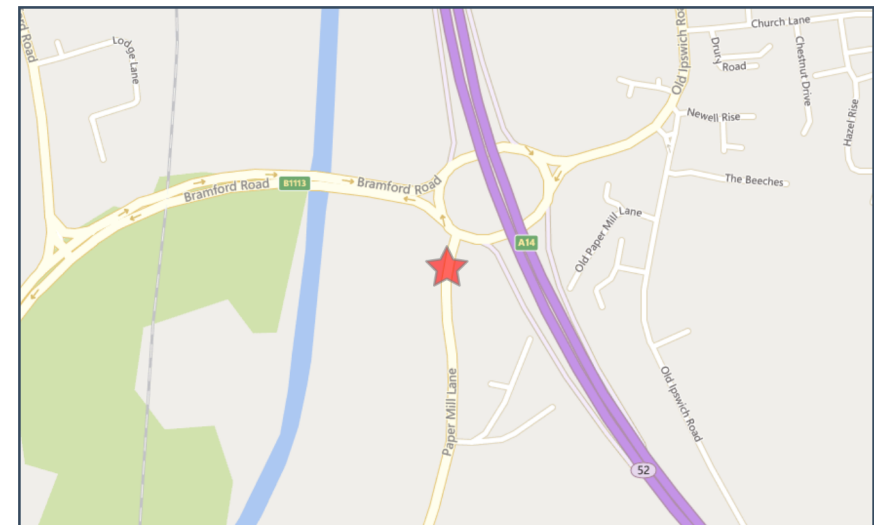

For more information about the data please visit: www.crashmap.co.uk/home/Faq
To subscribe to unlimited reports using CrashMap Pro visit www.crashmap.co.uk/Home/Premium_Services



Validated Data

Vehicles involved

Vehicle Ref	Vehicle Type	Vehicle Age	Driver Gender	Driver Age Band	Vehicle Maneouvre	First Point of Impact	Journey Purpose	Hit Object - On Carriageway	Hit Object - Off Carriageway
1	Car (excluding private hire)	11	Female	36 - 45	Vehicle is moving off	Front	Commuting to/from work	None	None
2	Car (excluding private hire)	14	Female	46 - 55	Vehicle is waiting to proceed normally but is held up	Back	Commuting to/from work	None	None

Casualties

Vehicle Ref	Casualty Ref	Injury Severity	Casualty Class	Gender	Age Band	Pedestrian Location	Pedestrian Movement
1	1	Slight	Driver or rider	Female	36 - 45	Unknown or other	Unknown or other
2	2	Slight	Vehicle or pillion passenger	Male	36 - 45	Unknown or other	Unknown or other

For more information about the data please visit: www.crashmap.co.uk/home/Faq

To subscribe to unlimited reports using CrashMap Pro visit www.crashmap.co.uk/Home/Premium_Services



Validated Data

Crash Date: Thursday, November 28, 2019 **Time of Crash:** 6:35:00 PM **Crash Reference:** 2019370927135

Highest Injury Severity:	Slight	Road Number:	A1071	Number of Casualties:	1
Highway Authority:	Suffolk			Number of Vehicles:	2
Local Authority:	Babergh District			OS Grid Reference:	612358 243647
Weather Description:	Raining without high winds				
Road Surface Description:	Wet or Damp				
Speed Limit:	30				
Light Conditions:	Darkness: street lights present and lit				
Carriageway Hazards:	None				
Junction Detail:	Roundabout				
Junction Pedestrian Crossing:	No physical crossing facility within 50 metres				
Road Type:	Single carriageway				
Junction Control:	Give way or uncontrolled				

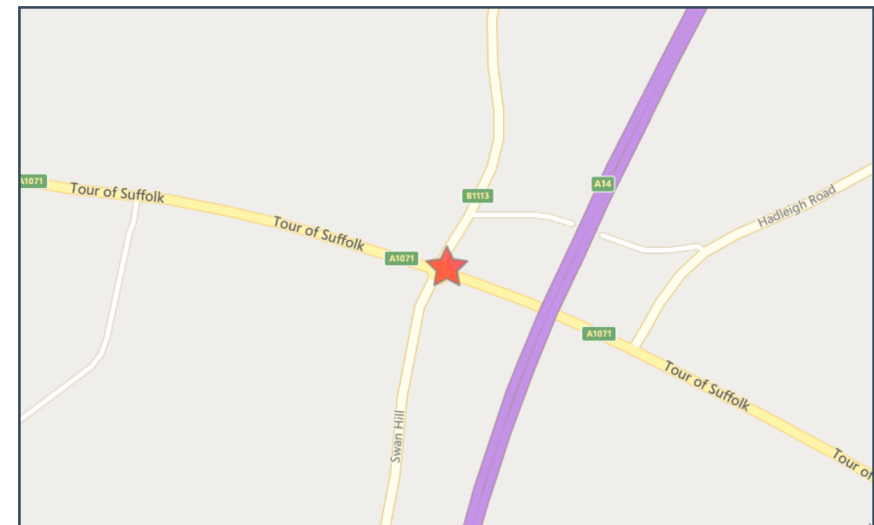

For more information about the data please visit: www.crashmap.co.uk/home/Faq
To subscribe to unlimited reports using CrashMap Pro visit www.crashmap.co.uk/Home/Premium_Services



Validated Data

Vehicles involved

Vehicle Ref	Vehicle Type	Vehicle Age	Driver Gender	Driver Age Band	Vehicle Maneouvre	First Point of Impact	Journey Purpose	Hit Object - On Carriageway	Hit Object - Off Carriageway
1	Car (excluding private hire)		3 Female	26 - 35	Vehicle proceeding normally along the carriageway, not on a bend	Nearside	Journey as part of work	None	None
2	Car (excluding private hire)		8 Male	46 - 55	Vehicle is in the act of turning right	Offside	Other	None	None

Casualties

Vehicle Ref	Casualty Ref	Injury Severity	Casualty Class	Gender	Age Band	Pedestrian Location	Pedestrian Movement
1	1	Slight	Driver or rider	Female	26 - 35	Unknown or other	Unknown or other

For more information about the data please visit: www.crashmap.co.uk/home/Faq

To subscribe to unlimited reports using CrashMap Pro visit www.crashmap.co.uk/Home/Premium_Services



Validated Data

Crash Date: Sunday, November 08, 2020 **Time of Crash:** 12:00:00 PM **Crash Reference:** 2020371003468

Highest Injury Severity:	Slight	Road Number:	A1071	Number of Casualties:	1
Highway Authority:	Suffolk			Number of Vehicles:	2
Local Authority:	Babergh District			OS Grid Reference:	612360 243642
Weather Description:	Fine without high winds				
Road Surface Description:	Dry				
Speed Limit:	30				
Light Conditions:	Daylight: regardless of presence of streetlights				
Carriageway Hazards:	None				
Junction Detail:	Roundabout				
Junction Pedestrian Crossing:	No physical crossing facility within 50 metres				
Road Type:	Roundabout				
Junction Control:	Give way or uncontrolled				

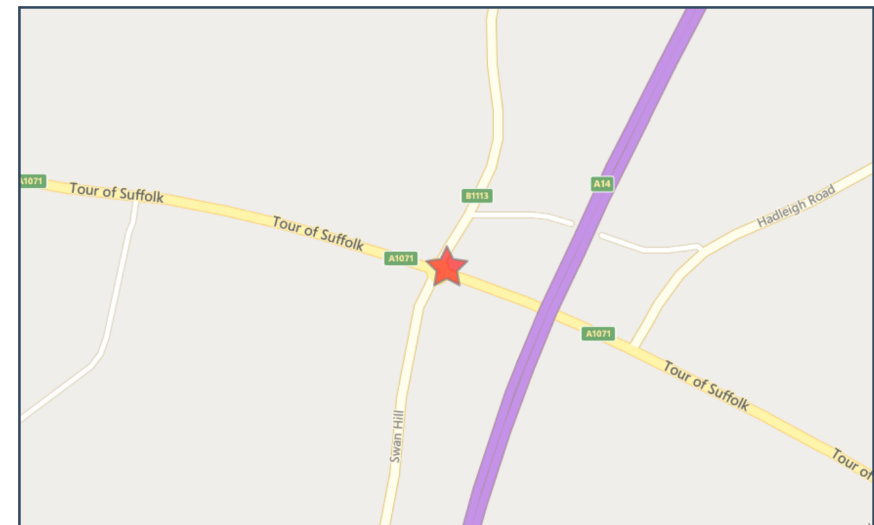

For more information about the data please visit: www.crashmap.co.uk/home/Faq
To subscribe to unlimited reports using CrashMap Pro visit www.crashmap.co.uk/Home/Premium_Services



Validated Data

Vehicles involved

Vehicle Ref	Vehicle Type	Vehicle Age	Driver Gender	Driver Age Band	Vehicle Manoeuvre	First Point of Impact	Journey Purpose	Hit Object - On Carriageway	Hit Object - Off Carriageway
1	Car (excluding private hire)		8 Male	46 - 55	Vehicle proceeding normally along the carriageway, not on a bend	Front	Other	None	None
2	Pedal cycle		-1 Male	46 - 55	Vehicle proceeding normally along the carriageway, not on a bend	Nearside	Other	None	None

Casualties

Vehicle Ref	Casualty Ref	Injury Severity	Casualty Class	Gender	Age Band	Pedestrian Location	Pedestrian Movement
	2	1 Slight	Driver or rider	Male	46 - 55	Unknown or other	Unknown or other

For more information about the data please visit: www.crashmap.co.uk/home/Faq

To subscribe to unlimited reports using CrashMap Pro visit www.crashmap.co.uk/Home/Premium_Services

EUROPEAN OFFICES

United Kingdom

AYLESBURY

T: +44 (0)1844 337380

BELFAST

belfast@slrconsulting.com

BRADFORD-ON-AVON

T: +44 (0)1225 309400

BRISTOL

T: +44 (0)117 906 4280

CARDIFF

T: +44 (0)29 2049 1010

CHELMSFORD

T: +44 (0)1245 392170

EDINBURGH

T: +44 (0)131 335 6830

EXETER

T: + 44 (0)1392 490152

GLASGOW

glasgow@slrconsulting.com

GUILDFORD

guildford@slrconsulting.com

LONDON

T: +44 (0)203 805 6418

MAIDSTONE

T: +44 (0)1622 609242

MANCHESTER (Denton)

T: +44 (0)161 549 8410

MANCHESTER (Media City)

T: +44 (0)161 872 7564

NEWCASTLE UPON TYNE

T: +44 (0)191 261 1966

NOTTINGHAM

T: +44 (0)115 964 7280

SHEFFIELD

T: +44 (0)114 245 5153

SHREWSBURY

T: +44 (0)1743 23 9250

STIRLING

T: +44 (0)1786 239900

WORCESTER

T: +44 (0)1905 751310

Ireland

DUBLIN

T: + 353 (0)1 296 4667

France

GRENOBLE

T: +33 (0)6 23 37 14 14

613000



249000

249000

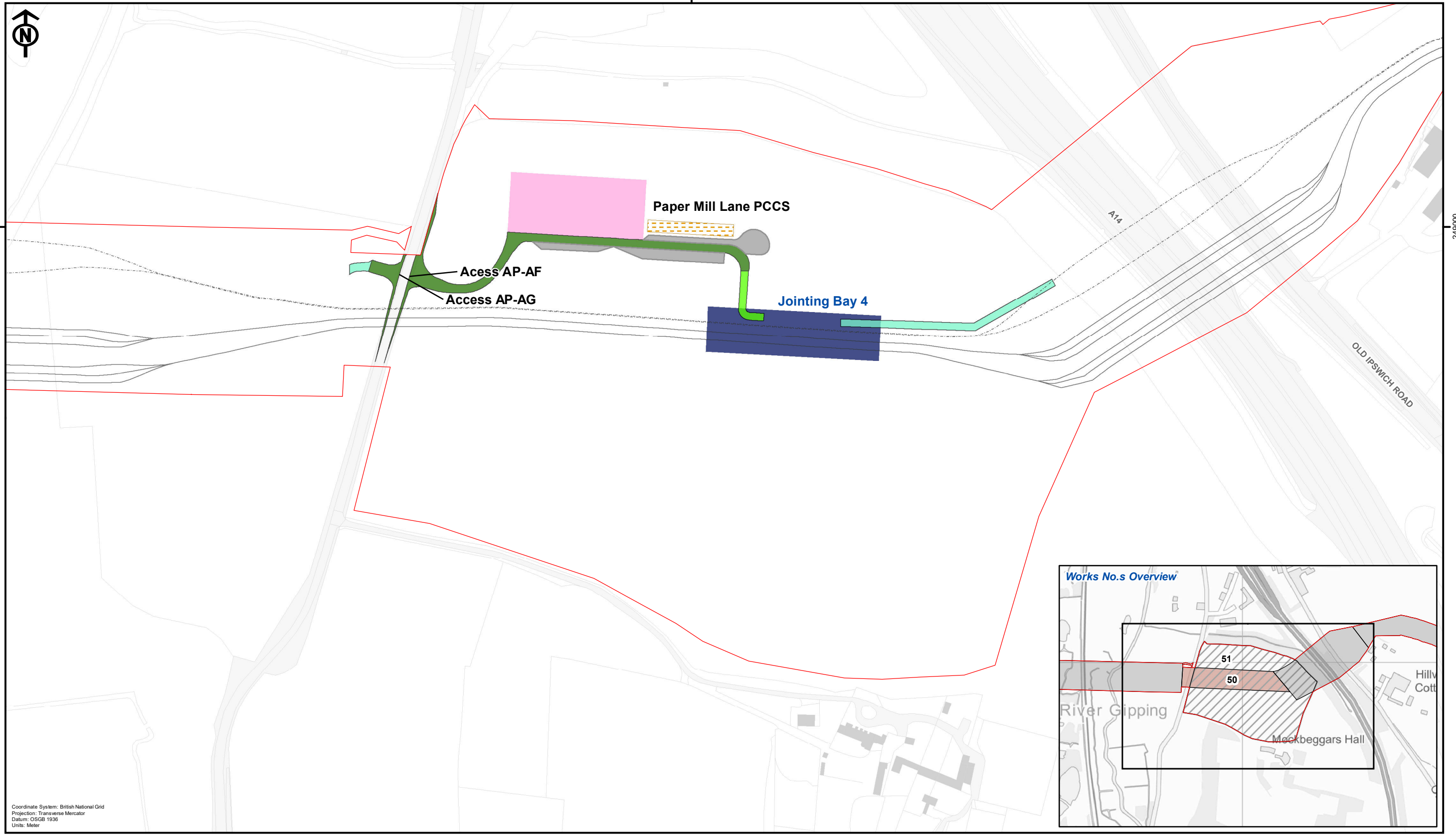

Coordinate System: British National Grid
 Projection: Transverse Mercator
 Datum: OSGB 1936
 Units: Meter

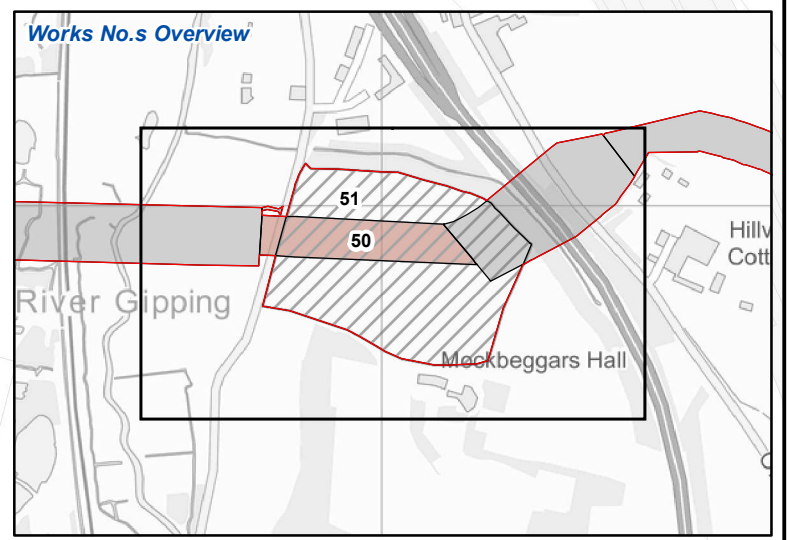

EA THREE DCO Corridor	HGV Turning, Cleaning and Washing	EA THREE Existing Cable Ducts	Works No.s 50 51
Primary Construction Consolidation Site	Trackway	EA ONE Existing Cable Ducts	
Jointing Bay Compound	Access Track		
Top Soil	Haul Road		



Rev	Date	By	Comment
B	05/04/2022	PW	Second Issue
A	31/03/2022	JRS	First Issue

Original A3 Plot Scale 1:2,500

0 50 100 Metres

© Crown copyright. All rights reserved. 2021 Licence number 0100031673.
 © British Crown and SeaZone Solutions Limited. All rights reserved. Products Licence No. 062010.001. This product has been derived in part from material obtained from the UK Hydrographic Office with the permission of the Controller of Her Majesty's Stationery Office and the UK Hydrographic Office (www.ukho.gov.uk).
 NOT TO BE USED FOR NAVIGATION.

Paper Mill Lane Works Stage

Figure 1: Site Context Plan

Drg No	05356.00006.12.0021.1 Site Context Plan
Rev	2
Date	05/04/2022
Layout	N/A

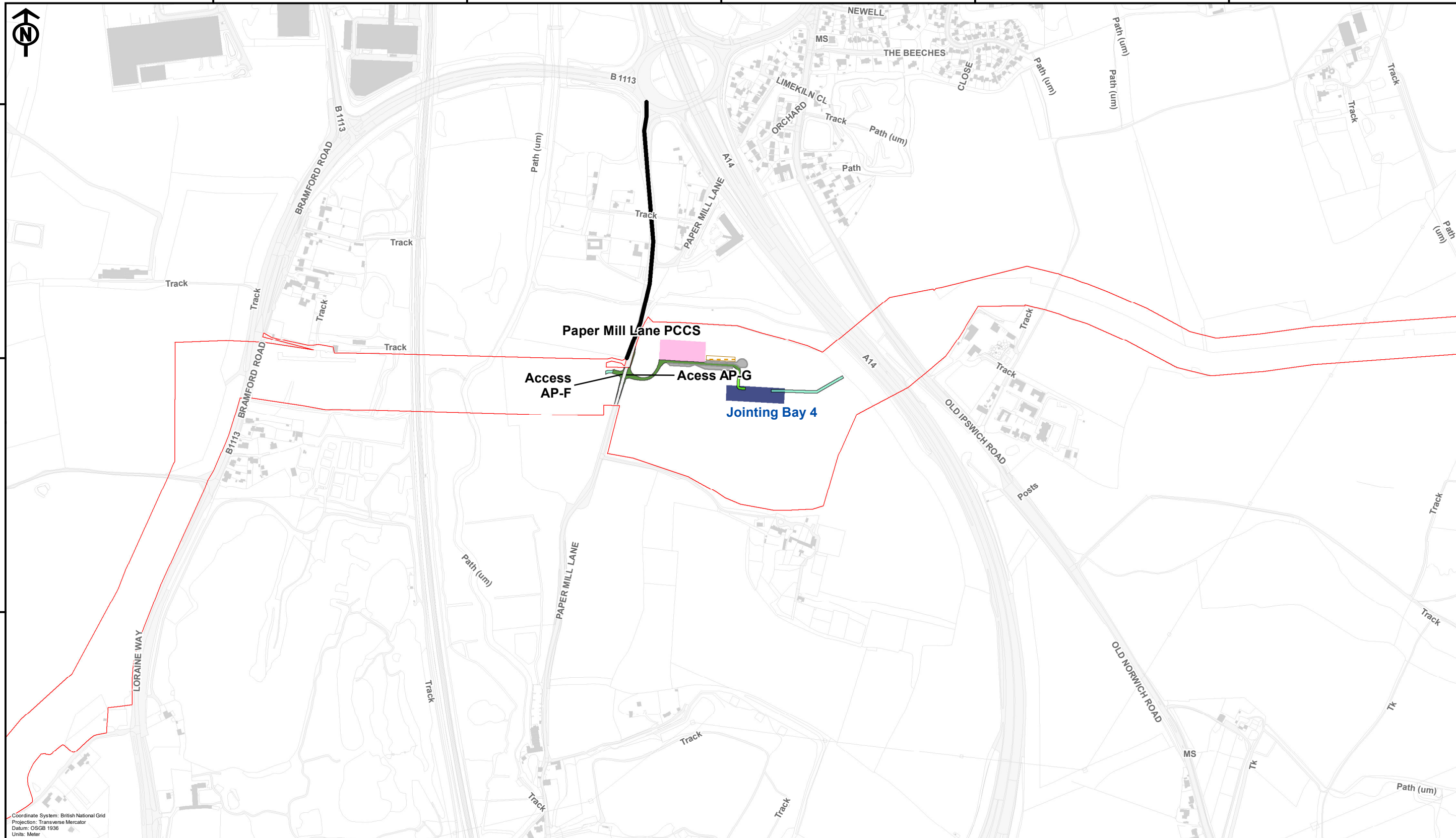

Coordinate System: British National Grid
 Projection: Transverse Mercator
 Datum: OSGB 1936
 Units: Meter

EA THREE DCO Corridor	HGV Turning, Cleaning and Washing	Top Soil
Primary Construction Consolidation Site	Trackway	Construction Access Route
Jointing Bay Compound	Access Track	
	Haul Road	



Rev	Date	By	Comment
B	12/04/2022	PW	Second Issue
A	31/01/2022	PW	First Issue

Original A3 Plot Scale 1:7,500

0 150 300 Metres

© Crown copyright. All rights reserved. 2021 Licence number 0100031673.
 © British Crown and SeaZone Solutions Limited. All rights reserved. Products Licence No. 082010.001. This product has been derived in part from material obtained from the UK Hydrographic Office with the permission of the Controller of Her Majesty's Stationery Office and the UK Hydrographic Office (www.ukho.gov.uk).
 NOT TO BE USED FOR NAVIGATION.

Paper Mill Lane Works Stage

Figure 2: Construction Access Route

Drg No	05356.00006.12.0078.1 Construction Access Route
Rev	2
Date	12/04/2022
Layout	N/A